

Doc No	CIP-8XXX SERIES SPECIFICATION	REV	PAGE	DATE
		A	1/71	2009. 04. 02.

**Card Issuing Machine for
Magnetic, Contact & IC Card
With Thermal Re-Writable Printer
(CIP-8XXXXXX Series)**

KYTronics Corp.,Ltd

3rd Floor, A-Dong,
Twin Town-Bldg, 703-2.
Gojan-Dong, AnSan-City,
Kyung Ki-Do, Korea(Zip : 425-906)
Tel : 82 - 31 - 485 - 9480
Fax : 82 - 31 - 485 - 9488
E-mail : sales@kytronics.co.kr
<http://www.kytronics.co.kr>

Doc No	CIP-8XXX SERIES SPECIFICATION	REV	PAGE	DATE
		A	2/71	2009. 04. 02.

REVISION HISTORY

No	DATE	DESCRIPTION	REV	PAGE
1	2009.04	First edition.	A	72
2				
3				
4				
5				
6				
7				
8				
9				
9				
10				
11				
12				
13				

Doc No	CIP-8XXX SERIES SPECIFICATION	REV	PAGE	DATE
		A	3/71	2009. 04. 02.

MODEL NAME INFORMATION

C I P - 8

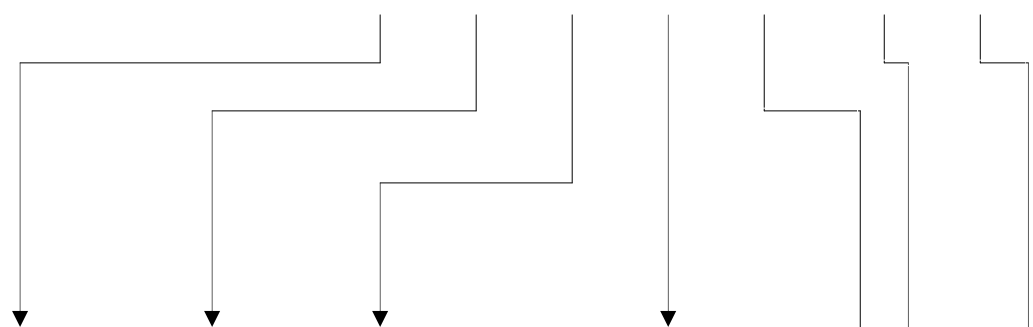

Interface	Function	MS / IC / RF	Track	Option
RS232C	8: Elevator Type Issuing Machine	0 : - 1 : MS Only 2 : MS & IC 3 : MS & RF 4 : MS & IC & RF 5 : IC Only 6 : RF Only 7 : IC & RF 9 : Custom product	0 : Without MS 1 : ISO 1 Trk 2 : ISO 2 Trk 3 : ISO 3 Trk 4 : ISO 1,2 Trk 5 : ISO 1,3 Trk 6 : ISO 2,3 Trk 7 : ISO 1,2,3 Trk	0: Without BEZEL 1: LOW-CO 2: HI-CO 3: LOW-CO & SHUTTER 4: HI-CO & SHUTTER 5: LOW-CO BEZEL 6: HIGH-CO BEZEL 7: SHUTTER 8: BEZEL * STANDARD BEZEL : SHORT BEZEL

Thickness		Option II	Option III
A: RFU B: 0.38T C: 0.5T D: 0.76T E: 0.84T F: 1.0T	G: RFU H: 0.38T I: 0.5T J: 0.76T K: 0.84T L: 1.0T	0:500PCS 1:1000PCS 2:1500PCS	D: Card Drop (Without Bezel)
 With capture box	 Without capture box		

Doc No	CIP-8XXX SERIES SPECIFICATION	REV	PAGE	DATE
		A	4/71	2009. 04. 02.

C O N T E N T S

Overview -----	5
System Block Diagram -----	6
Specification -----	8
Magnetic Card Process -----	10
IC Card Process -----	11
RF Card Process -----	12
Communication Interface -----	13
Technical Drawing -----	19
Command Detail -----	22
Error Detail -----	67
Precautions -----	72

Doc No	CIP-8XXX SERIES SPECIFICATION	REV	PAGE	DATE
		A	5/71	2009. 04. 02.

OVERVIEW

CIP-8XXX Series is a set of card issuing machine for the magnetic, IC, and RF card in conjunction with the CIP-8XXX and KYT-3XXX series and Thermal Re-Writable Printer module.. This model can be used for magnetic card conforming to the ISO7816-2 standard and most of the IC cards conforming with the ISO7816-4 T=0,T=1. Additionally, this model also can be used for the RF card conforming to the MIFARE.

This model simplified the command for magnetic card, minimize the delay time occurs in the communication data processing, and improved the speed due to function to issue the all tracks at a time.

This model has the following advantages:

- 1) With bottom-up direction card hopper, the CIP-8xxx can be fitted to most type of existing Parking system and Highway fare collection system and various Entry control system.
- 2) With exchangeable cartridge, card cards can be loaded easily and quickly.
- 3) With big capacity of cartridge, long and un-intended automatic operation is allowed
- 4) Flexible card selection is allowed since the CIP-8xxx can provide all the magnetic, contact and contactless IC card issuing function is prepared.

As an automatic issuing machine, this model can be used in issuing most types of credit card and debit card in financial area.

Doc No	CIP-8XXX SERIES SPECIFICATION	REV	PAGE	DATE
		A	6/71	2009. 04. 02.

SYSTEM BLOCK DIAGRAM

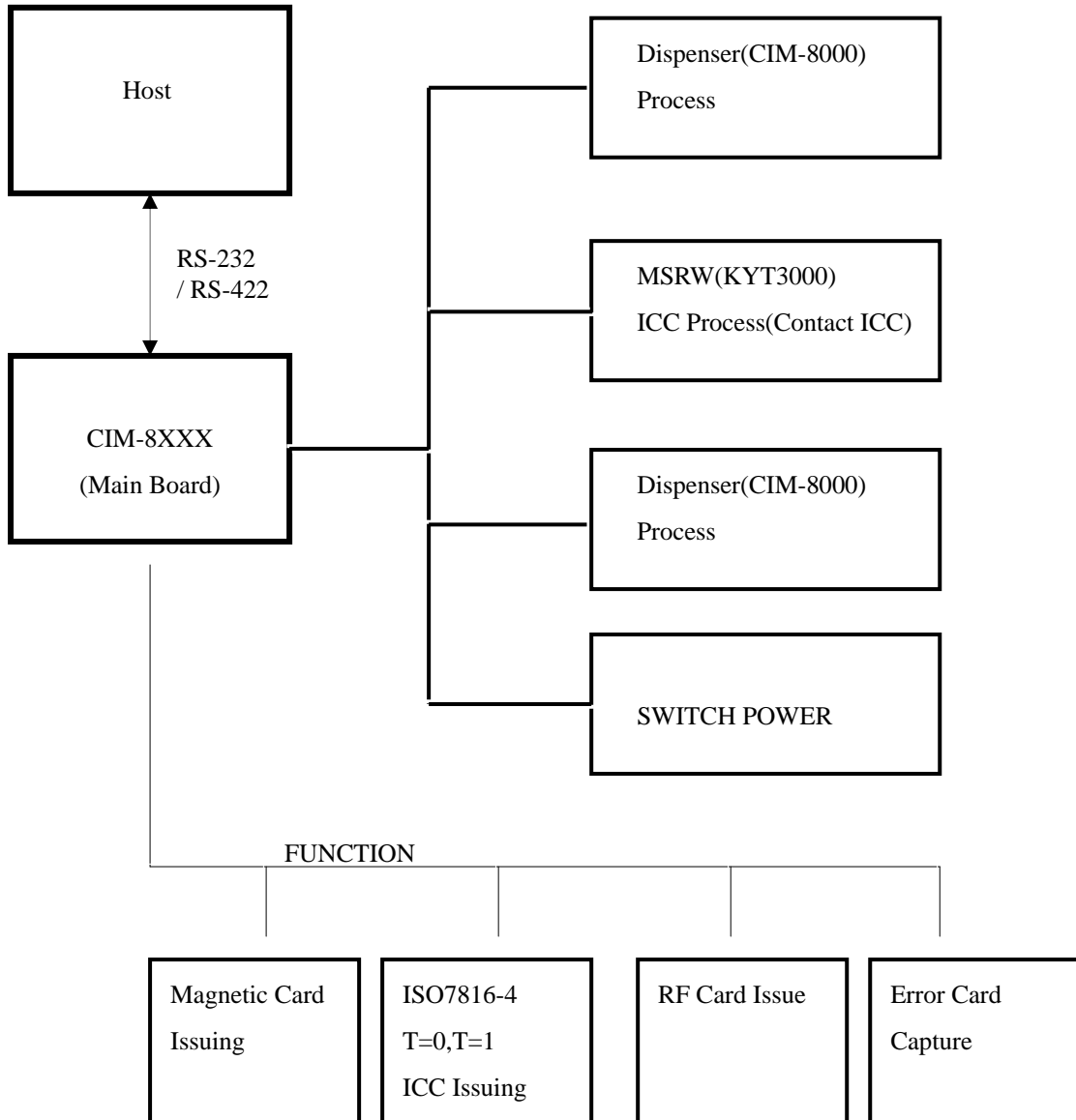

Doc No	CIP-8XXX SERIES SPECIFICATION	REV	PAGE	DATE
		A	7/71	2009. 04. 02.

◆ *RS – 232 Connection*

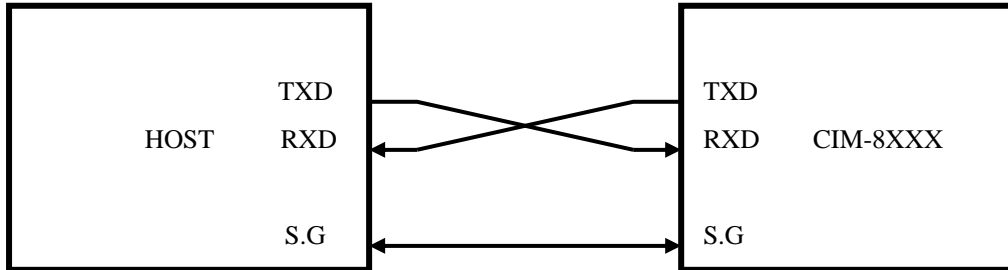

CASE 1) Part Number : RED-9S-LNA(HIROSE)

Pin No	INDEX	Remark
2	RXD	Receive
3	TXD	Transmit
5	S.G	Signal Ground

◆ *RS422 Connection*

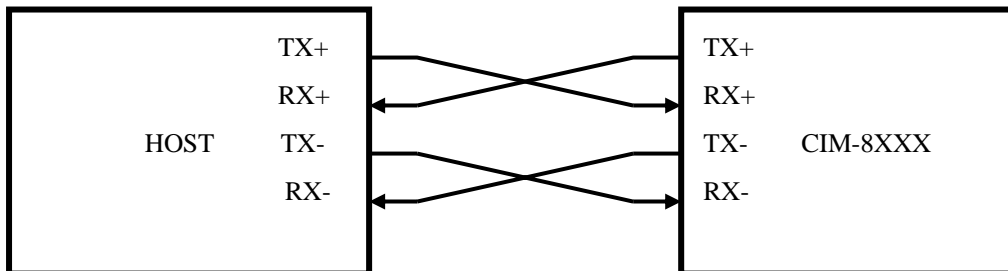

CASE 1) Part Number : RED-9S-LNA(HIROSE)

Pin No	INDEX	Remark
1	TX+	
4	RX+	
6	TX-	
8	RX-	

Doc No	CIP-8XXX SERIES SPECIFICATION	REV	PAGE	DATE
		A	8/71	2009. 04. 02.

SPECIFICATIONS

◆ *basic functions*

	Spec	Remark
Dimension		Refer to page 20
Weight	500pcs: 15Kg 1000pcs: 19Kg 1500pcs: 23Kg	Refer to page 20
Input power	AC 110 ~ AC 220V Free voltage	
Card Feeding Speed	150 mm/Sec ±10%	

◆ *Environment Requirements*

Operating Locus : In door use Only

Ambient Temperature

Storage : -20 °C to 70 °C(No functional error to be found in 12 hours after returning to normal environment)

Operating : 5 °C to 50°C (In 0°C to +5°C range, all specifications but 'Warped card' to be satisfied)

Ambient Relative Humidity

Storage : 0% to 95% RH(No functional error to be found in 12 hours after returning to normal environment)

Operating : 5 % 90% RH(No Condensation)

Vibration

: Amplitude 2mm, 10 to 50 Hz in X, Y, Z directions for 30min, 2G or less

Shock Endurance

: 30G, 11ms

Doc No	CIP-8XXX SERIES SPECIFICATION	REV	PAGE	DATE
		A	9/71	2009. 04. 02.

◆ *Controller Environment*

Communication

: RS422 OR RS232C Interface

: Baud Rate – 9600 BPS

– 19200 BPS

– 38400BPS(Default)

– 57600BPS

: 8Data bit, 1 Start bit, None Parity bit, 1 Stop Bit

Doc No	CIP-8XXX SERIES SPECIFICATION	REV	PAGE	DATE
		A	10/71	2009. 04. 02.

MAGNETIC CARD PROCESS

KYT-3000 series is able to encode data on all three tracks of ISO 1,2 and 3 in one pass, which makes read / write process time shorter. It is a basic and standard option to read and write to Low – Co card.

◆ *Total processing time* : Less than 1.2 Sec

◆ *Life and Reliability.*

Life of Head : Approximately 500,000 passes.
(One pass is for forward and backward movement)

Error Rate : 5/1000 cycle.

◆ *Reference Standards.*

: ISO 7811-1,2,3,4,5 : identification cards – Recording technique

◆ *Recording.*

	ISO Track 1	ISO Track 2	ISO Track 3
BPI	210	75	210
Capacity	Max 79	Max 40	Max 107
Reading Methods	F2F		
Length	Variable		
Card thickness	Plastic : 0.76 ±0.08mm		

Doc No	CIP-8XXX SERIES SPECIFICATION	REV	PAGE	DATE
		A	11/71	2009. 04. 02.

IC CARD PROCESS

This model provides most type of IC card compliant to ISO7816 T=0,T=1 .

◆ *Processing time* : Less than 1 Sec

◆ *Number and Location of the contacts on IC Card.*

: Number and location of the contacts on IC Card is specified in ISO 7816-2

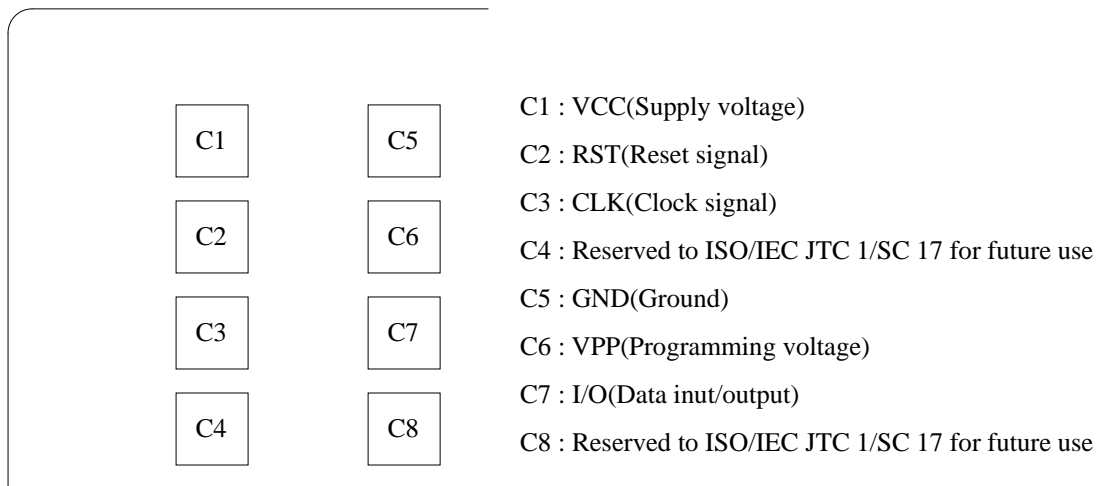

◆ *Life and Reliability.*

IC Contact : Approximately 1,000,000 passes

Error Rate : 5/1000 cycle

Doc No	CIP-8XXX SERIES SPECIFICATION	REV	PAGE	DATE
		A	12/71	2009. 04. 02.

RF CARD PROCESS

The RF module supports most of RF cards conforming with the ISO14443-3 Type A (MIFARE Card) with 8Kbits memory.

◆ *Processing time* : Once Block.

Command	Parameter	Time (mSec)		Note
		Type	Max	
Card Read	1 Block	100		Without card moving
Card Write	1 Block	150		Without card moving, With Verify
Card Decrement	1 Block	120		Without card moving
Card Increment	1 Block	120		Without Card moving

◆ *Operating Frequency.*

Operating Frequency : 13.56 MHz

Data Transfer Baud : Baud rate 106Kbaud

Doc No	CIP-8XXX SERIES SPECIFICATION	REV	PAGE	DATE
		A	13/71	2009. 04. 02.

COMMUNICATION INTERFACE

◆ *Communication Method.*

Asynchronous, Half duplex.

Baud Rate : 9600 – 57600Bps , Default : 38400Bps

Start Bit : 1Bit

Data Length : 8Bit

Parity : None

Stop Bit : 1Bit

◆ *Communication Protocol Format.*

1 *Command Frame Format.*

SOH	Null	Length	STX	CMD	DATA	ETX	BCC
1 byte	1 byte	2 byte	1 byte	3 byte	X byte	1 byte	1 byte

2 *Positive Response Frame Format.*

SOH	Null	Length	STX	CMD	GOOD	0x01	DATA	ETX	BCC
1 byte	1 byte	2 byte	1 byte	3 byte	2 byte	1 byte	X byte	1 byte	1 byte

3 *Negative Response Frame Format.*

SOH	Null	Length	STX	CMD	E-Code	0x00	ETX	BCC
1 byte	1 byte	2 byte	1 byte	3 byte	2 byte	1 byte	1 byte	1 byte

4 *BCC (Check Sum).*

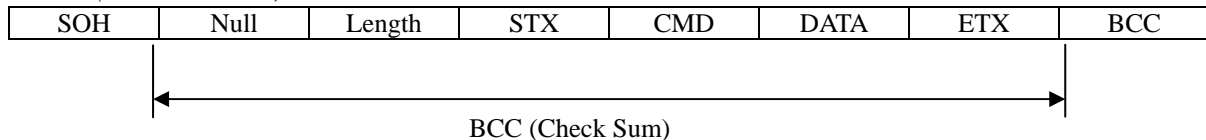

Command Frame BCC = Null ^ Length ^ STX ^ CMD ^ DATA ^ ETX.

Positive Response BCC = Null ^ Length ^ STX ^ CMD ^ GOOD ^ 0x01 ^ DATA ^ ETX.

Negative Response BCC = Null ^ Length ^ STX ^ CMD ^ E-Code ^ ETX.

Doc No	CIP-8XXX SERIES SPECIFICATION	REV	PAGE	DATE
		A	15/71	2009. 04. 02.

7.2 Inquiry.

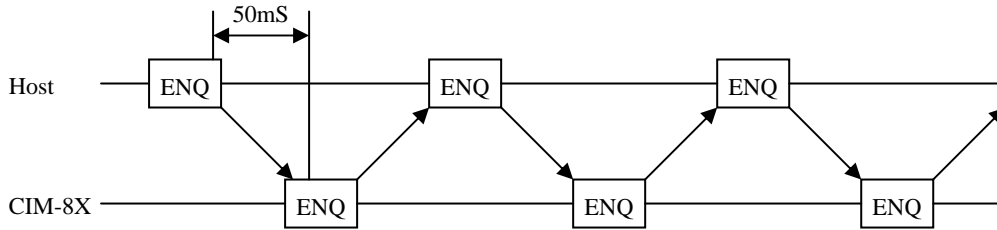

7.3 Sequence.

7.3.1 General.

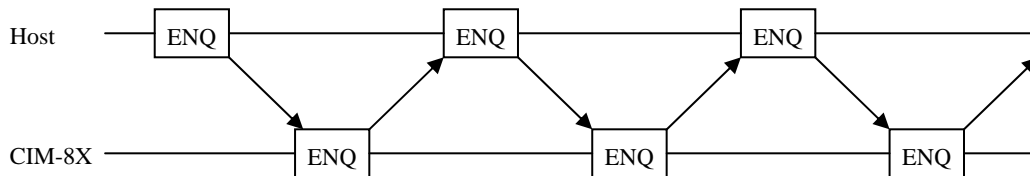
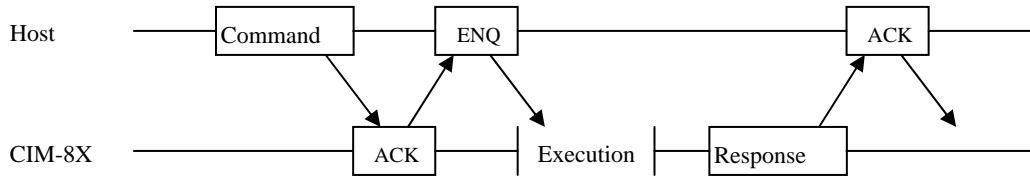

Doc No	CIP-8XXX SERIES SPECIFICATION	REV	PAGE	DATE
		A	16/71	2009. 04. 02.

7.3.2 Event

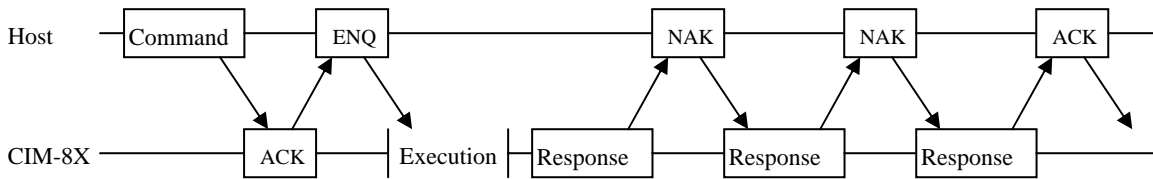
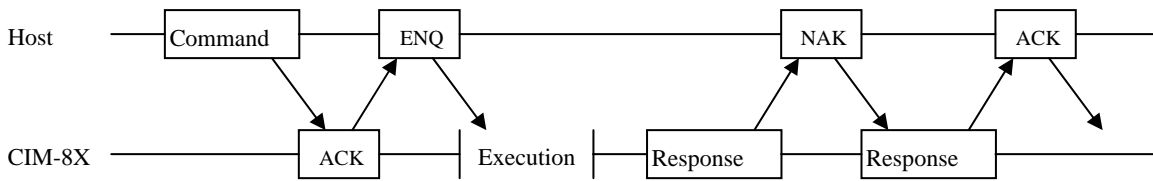
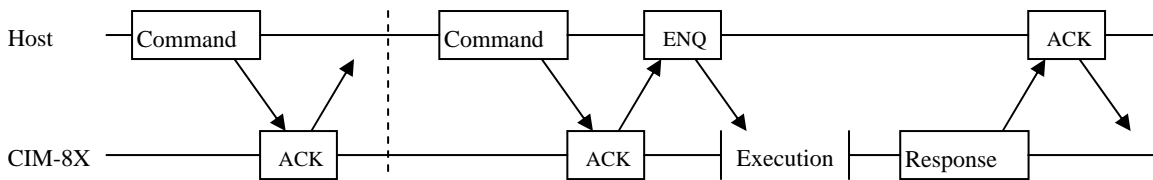
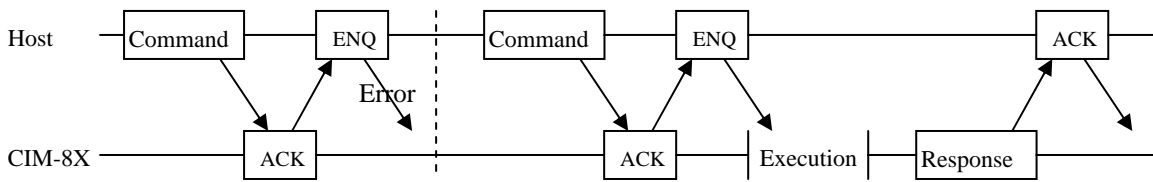
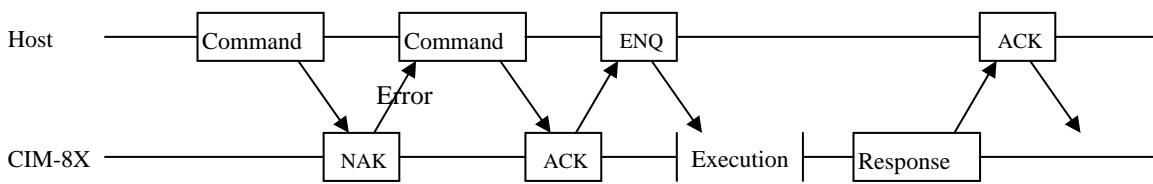
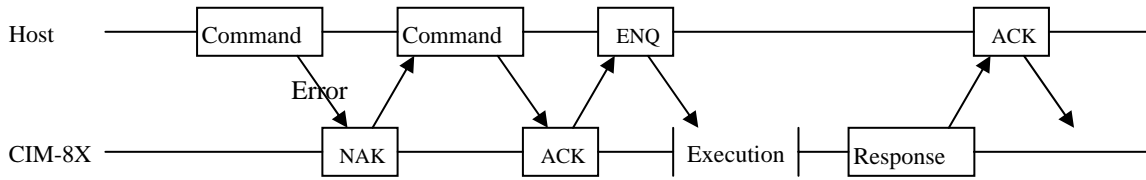

Doc No	CIP-8XXX SERIES SPECIFICATION	REV	PAGE	DATE
		A	17/71	2009. 04. 02.

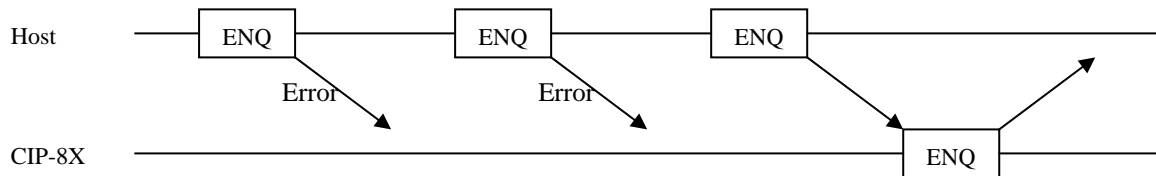
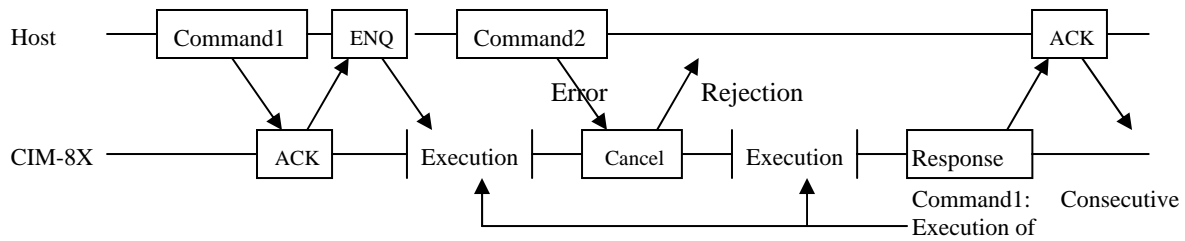
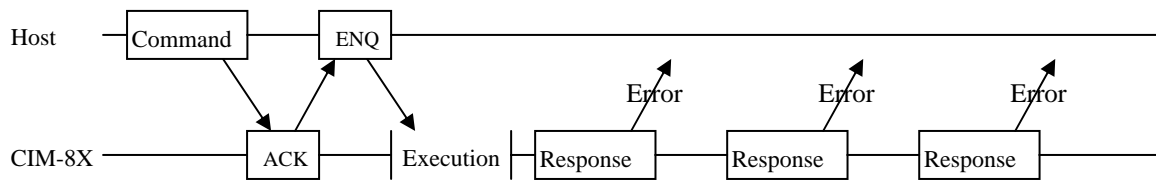
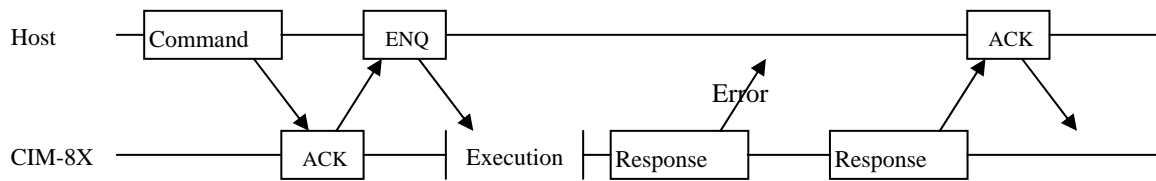
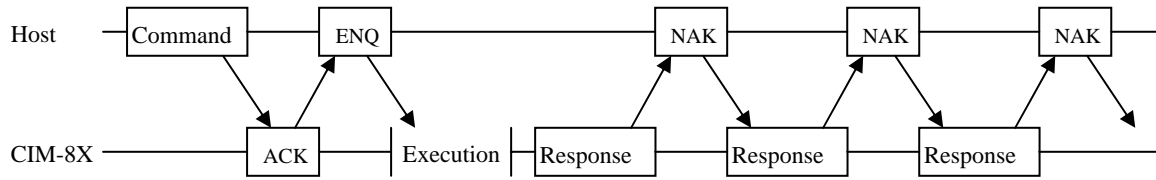

Doc No	CIP-8XXX SERIES SPECIFICATION	REV	PAGE	DATE
		A	18/71	2009. 04. 02.

- When received the NAK packet consecutively.

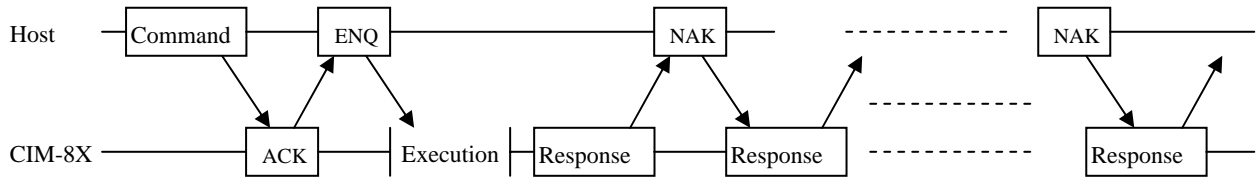

- When the Host sends the command without the ACK packet.

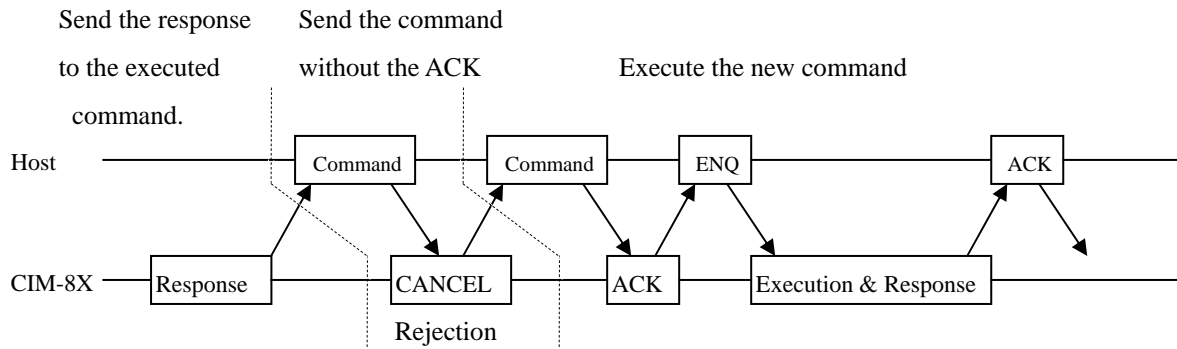

The terminal should ignore the command received before it sends the ACK packet, send the CANCEL packet. The second command will be treated as the ACK packet and executed with no ACK.

Doc No	CIP-8XXX SERIES SPECIFICATION	REV	PAGE	DATE
		A	19/71	2009. 04. 02.

TECHNICAL DRAWING

MODEL : CIP-86XXXX

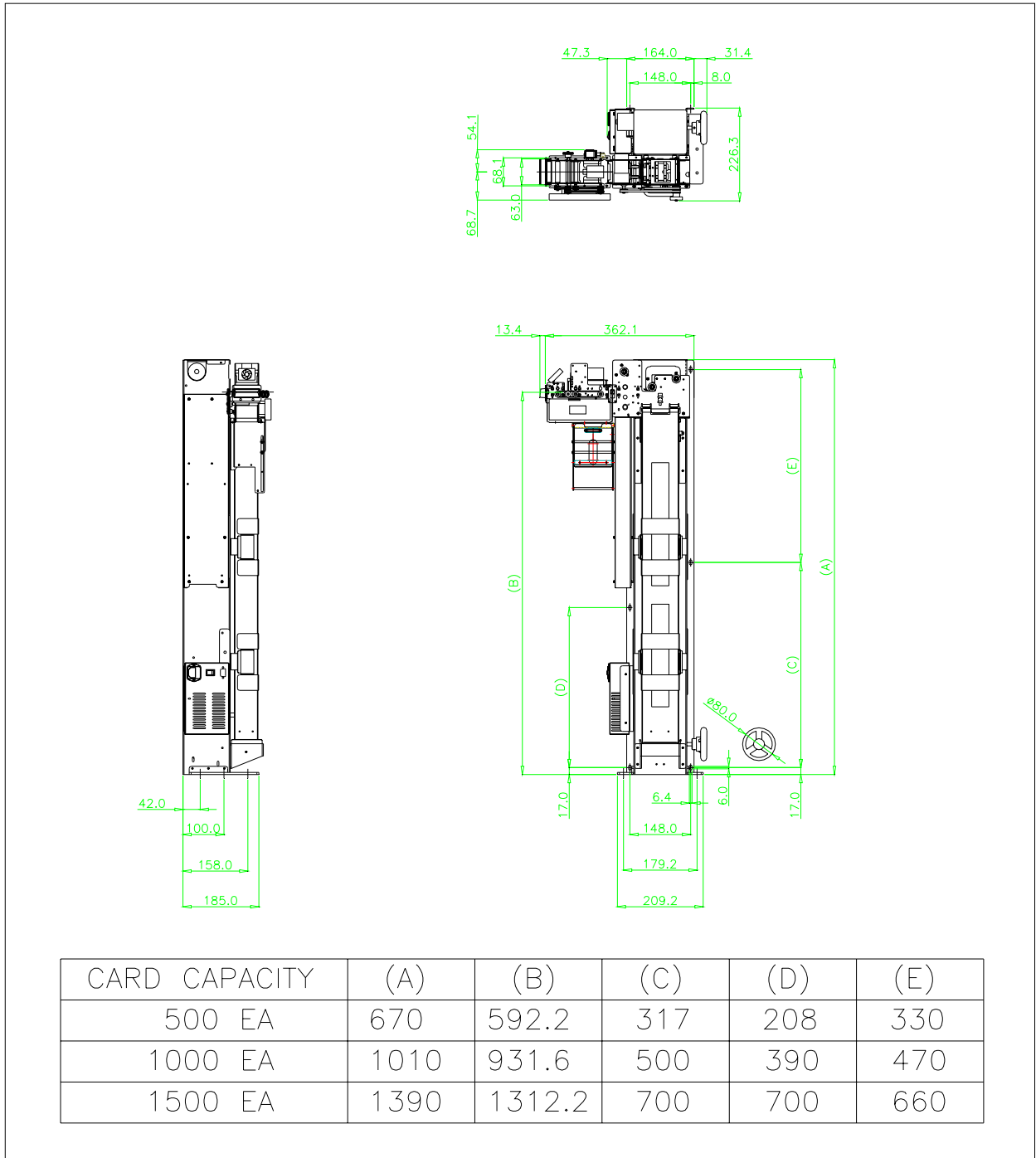

Doc No	CIP-8XXX SERIES SPECIFICATION	REV	PAGE	DATE
		A	20/71	2009. 04. 02.

< FEEDER PART SENSOR POSITION >

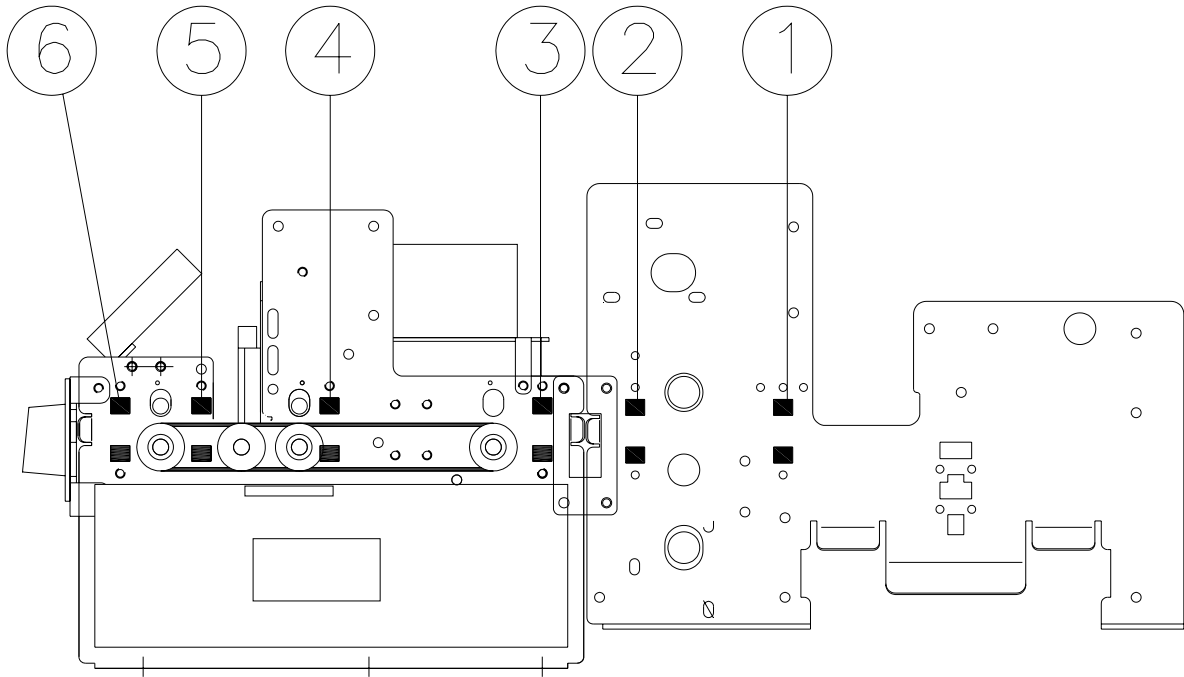

Doc No	CIP-8XXX SERIES SPECIFICATION	REV	PAGE	DATE
		A	21/71	2009. 04. 02.

COMMAND DETAIL

◆ *Applicable Models*

Commands	Models	Note
COMMON	All CIP8XXX Series	
MAGNETIC CARD	CIP81XXX(D), CIP82XXX(D), CIP83XXX(D), CIP4XXX(D)	
IC CARD	CIP82XXX(D), CIP84XXX(D), CIP85XXX(D), CIP7XXX(D)	
RF CARD	CIP83XXX(D), CIP84XXX(D), CIP6XXX(D), CIP7XXX(D)	

◆ *Command List*

	Item	Cm0	Cm1	Cm2	Detail	Note
COMMON	STATUS	'C'	'1'	'1'	Get Model	
		'C'	'1'	'2'	Get Firmware Version	
		'C'	'1'	'3'	Get Cartridge Status	
		'C'	'1'	'4'	Get Status List	
		'C'	'1'	'5'	Get Error List	
		'C'	'1'	'6'	Get Card Position	
		'C'	'1'	'9'	Get the flags	
	SETTING_1	'C'	'2'	'1'	Set RTC IC	Check
		'C'	'2'	'4'	Set Retry Count	Check
		'C'	'2'	'5'	Set Buzz On/Off Cont.	Check
		'C'	'2'	'6'	Set Baud Rate	Check
	SETTING_2	'C'	'4'	'0'	Set User Buzz	
		C	'4'	'2'	Software Reset	
	MOVE	'C'	'3'	'1'	Card Move From Cartridge	
		'C'	'3'	'2'	Card Move To	
		'C'	'3'	'4'	Card Capture	Backward
		'C'	'3'	'6'	Card Eject (Drop)	Forward
		'C'	'3'	'7'	Card Eject (Hold)	Forward
		'C'	'3'	'8'	Raise the Lift	
		'C'	'3'	'9'	Card Move To Cartridge	
		'C'	'4'	'4'	Lower the Lift for collecting	
'C'		'4'	'5'	Lower the Lift		
MAGNETIC CARD	MAGNETIC READ / WRITE	'M'	'3'	'1'	Magnetic Card Read	
		'M'	'3'	'3'	Magnetic Card Write	Verify
		'M'	'3'	'4'	Magnetic Card Write From Cartridge	Verify
		'M'	'3'	'5'	Magnetic Card All Track Read	
		'M'	'3'	'A'	Magnetic Card Read for binary format	Optional
		'M'	'3'	'B'	Magnetic Card Write for binary format	Optional
	'M'	'3'	'C'	Magnetic Card Write from Cartridge for binary format	Optional	
CLEANING	'M'	'5'	'1'	MSRW Header Cleaning		
IC CARD	IC CONTROL	'I'	'2'	'1'	IC Card Reset	
		'I'	'2'	'2'	IC Card Direct Control	
RF CARD	RF CARD READ / WRITE	'R'	'3'	'1'	RF Card Read in Block Range	
		'R'	'3'	'2'	RF Card Write in Block Range	Verify
		'R'	'3'	'6'	RF Card Read in Sector Range	
		'R'	'3'	'7'	RF Card Write in Sector Range	
	BALANCE	'R'	'4'	'1'	Balance Increment	
		'R'	'4'	'2'	Balance Decrement	
	SECRET KEY	'R'	'5'	'1'	Change 'Secret Key' to other Key	
		'R'	'5'	'2'	Change 'Secret Key' to all the same Key value	

Doc No	CIP-8XXX SERIES SPECIFICATION			REV	PAGE	DATE
				A	22/71	2009. 04. 02.
PRINTER	CHANGE	'R'	'5'	'3'	Select 'Secret Key Index'	
		'R'	'5'	'4'	Change 'RF Card Secret Key' to other Key	
		'R'	'6'	'1'	Check RF card in antenna area	
	PRINT	'P'	'1'	'0'	Card Print.	
	CARD ERASE	'P'	'2'	'0'	All of the Card Erase.	
		'P'	'2'	'1'	Partial of the Card Erase.	
	SETTING	'P'	'3'	'0'	Select Erase Line	
		'P'	'3'	'1'	Select Card Position	
		'P'	'3'	'2'	Thermal Header Cleaning	

Doc No	CIP-8XXX SERIES SPECIFICATION	REV	PAGE	DATE
		A	23/71	2009. 04. 02.

◆ *Common*

These are the command set that all the CIP8XXX Series use. These commands include the terminal setting and the card movement related commands.

The 'STATUS' commands provide the function to check the current terminal status and the errors occurred during the command execution.

The 'SETTING' commands consist of commands for setting the terminal and these commands is easy to use because the same command can use for both setting and checking the terminal.

The 'MOVE' commands consist of commands used commonly like the card eject and capture command.

Commands Set:

Item	Cm0	Cm1	Cm2	Detail	Note
STATUS	'C'	'1'	'1'	Get Model	
	'C'	'1'	'2'	Get Firmware Version	
	'C'	'1'	'3'	Get Cartridge Status	
	'C'	'1'	'4'	Get Status List	
	'C'	'1'	'5'	Get Error List	
	'C'	'1'	'6'	Get Card Position	
	'C'	'1'	'9'	Get the flags	
SETTING	'C'	'2'	'1'	Set RTC IC	Check
	'C'	'2'	'4'	Set Retry Count	Check
	'C'	'2'	'5'	Set Buzz On/Off Cont.	Check
	'C'	'2'	'6'	Set Baud Rate	Check
	'C'	'4'	'0'	Set User Buzz	
	C	'4'	'2'	Software Reset	
MOVE	'C'	'3'	'1'	Card Move From Cartridge	
	'C'	'3'	'2'	Card Move To	
	'C'	'3'	'4'	Card Capture	Backward
	'C'	'3'	'6'	Card Eject (Drop)	Forward
	'C'	'3'	'7'	Card Eject (Hold)	Forward
	'C'	'3'	'8'	Raise the Lift	

Doc No	CIP-8XXX SERIES SPECIFICATION	REV	PAGE	DATE
		A	24/71	2009. 04. 02.

1 STATUS / SETTING

1.1 "C11" : It is to check out Model number of CIP8XXXX.

☞ Command Format

SOH	Null	Length	STX	"C11"	ETX	Bcc
-----	------	--------	-----	-------	-----	-----

☞ Positive Response Format

SOH	Null	Length	STX	"C11"	GOOD	0x01	DATA	ETX	Bcc
-----	------	--------	-----	-------	------	------	------	-----	-----

☞ Negative Response Format

SOH	Null	Length	STX	"C11"	E-Code	0x00	ETX	Bcc
-----	------	--------	-----	-------	--------	------	-----	-----

☞ Response Data Structure

Model No	
30 Byte (ASCII)	

1.2 "C12" : It is to check out Firmware Version of CIP8XXXX

☞ Command Format

SOH	Null	Length	STX	"C12"	ETX	Bcc
-----	------	--------	-----	-------	-----	-----

☞ Positive Response Format

SOH	Null	Length	STX	"C12"	GOOD	0x01	DATA	ETX	Bcc
-----	------	--------	-----	-------	------	------	------	-----	-----

☞ Negative Response Format

SOH	Null	Length	STX	"C12"	E-Code	0x00	ETX	Bcc
-----	------	--------	-----	-------	--------	------	-----	-----

☞ Response Data Structure

VERSION	
30 Byte (ASCII)	

1.3 "C13" : It is check out status of Cartridge of CIP8XXXX

☞ Command Format

SOH	Null	Length	STX	"C13"	ETX	Bcc
-----	------	--------	-----	-------	-----	-----

☞ Positive Response Format

SOH	Null	Length	STX	"C13"	GOOD	0x01	DATA	ETX	Bcc
-----	------	--------	-----	-------	------	------	------	-----	-----

☞ Negative Response Format

SOH	Null	Length	STX	"C13"	E-Code	0x00	ETX	Bcc
-----	------	--------	-----	-------	--------	------	-----	-----

☞ Response Data Structure

CARTRIDGE 1	CARTRIDGE 2
1Byte (Hex)	0x00(Constant)

☞ Data Variable

<Cartridge>

Code	Status
0x01	Cartridge Good
0x02	Cartridge Warning
0x03	Cartridge Empty

☞ Note

Doc No	CIP-8XXX SERIES SPECIFICATION	REV	PAGE	DATE
		A	25/71	2009. 04. 02.

Cartridge Status	Detail
Cartridge Good	Too many cards loading ¹⁾
Cartridge Warning	There aren't many card left in the cartridge. (Warning sensor)
Cartridge Empty	No cards in cartridge

1) The cartridge status is detected by the sensor behind the cartridge. The number of cards can be changed.

1.4 "C14" : It is to check out current Status of CIP8XXXX

☞ Command Format

SOH	Null	Length	STX	"C14"	ETX	Bcc
-----	------	--------	-----	-------	-----	-----

☞ Positive Response Format

SOH	Null	HL	Length	"C14"	GOOD	0x01	DATA	ETX	Bcc
-----	------	----	--------	-------	------	------	------	-----	-----

☞ Negative Response Format

SOH	Null	Length	STX	"C14"	E-Code	0x00	ETX	Bcc
-----	------	--------	-----	-------	--------	------	-----	-----

☞ Response Data Structure

Error Code (1)	---	Error Code (N)
----------------	-----	----------------

High Byte	Low Byte
2Byte	

☞ Note

You can identify the cartridge status, motor status, card status (jamming) and communication status through the Error Code in the response data structure.

1.5 "C15" : It is to check out error while Command is being executed.

☞ Command Format

SOH	Null	Length	STX	"C15"	ETX	Bcc
-----	------	--------	-----	-------	-----	-----

☞ Positive Response Format

SOH	Null	Length	STX	"C15"	GOOD	0x01	DATA	ETX	Bcc
-----	------	--------	-----	-------	------	------	------	-----	-----

☞ Negative Response Format

SOH	Null	Length	STX	"C15"	E-Code	0x00	ETX	Bcc
-----	------	--------	-----	-------	--------	------	-----	-----

☞ Response Data Structure

Error Time (1)	Error Code (1)	---	Error Time (N)	Error Code (N)
7Byte (BCD)	2Byte (Hex)	---	7Byte (BCD)	2Byte (Hex)

High Year	Low Year	Month	Day	Hour	Minute	Second
1Byte	1Byte	1Byte	1Byte	1Byte	1Byte	1Byte

High Byte	Low Byte
1Byte	1Byte

Doc No	CIP-8XXX SERIES SPECIFICATION	REV	PAGE	DATE
		A	26/71	2009. 04. 02.

☞ Note

This command is only correspond to the error occurred during command execution. The time when an error is occurred is represented to the BCD, while the error code to the HEX.

1.6 “C16” : It is to check out current card position of CIP8XXXX.

☞ Command Format

SOH	Null	Length	STX	“C16”	ETX	Bcc
-----	------	--------	-----	-------	-----	-----

☞ Positive Response Format

SOH	Null	Length	STX	“C16”	GOOD	0x01	DATA	ETX	Bcc
-----	------	--------	-----	-------	------	------	------	-----	-----

☞ Negative Response Format

SOH	Null	Length	STX	“C16”	E-Code	0x00	ETX	Bcc
-----	------	--------	-----	-------	--------	------	-----	-----

☞ Response Data Structure

Card Position
1Byte (Hex)

<Card Position>

Number	Code	Sensor
1	0x01	SENSOR 1
2	0x02	SENSOR 2
3	0x04	SENSOR 3
4	0x08	SENSOR 4
5	0x10	SENSOR 5
6	0x20	SENSOR 6
7	0x40	SENSOR 7
8	0x80	SENSOR 8

NOTE: Refer to page 21.

1.1 “C19” : It is to check the flags of CIP8XXXX unit.

☞ Command Format

SOH	Null	Length	STX	“C19”	ETX	Bcc
-----	------	--------	-----	-------	-----	-----

☞ Positive Response Format

SOH	Null	Length	STX	“C19”	GOOD	0x01	DATA	ETX	Bcc
-----	------	--------	-----	-------	------	------	------	-----	-----

☞ Negative Response Format

SOH	Null	Length	STX	“C19”	E-Code	0x00	ETX	Bcc
-----	------	--------	-----	-------	--------	------	-----	-----

☞ Response Data Structure

Flag
1 Byte (HEX)

<Flag information>

Code	Status
0x01	The button is pushed

Doc No	CIP-8XXX SERIES SPECIFICATION	REV	PAGE	DATE
		A	27/71	2009. 04. 02.

2 SETTING

2.1 “C21” : It is to set or to check ‘RTC IC’.

☞ Command Format

SOH	Null	Length	STX	“C21”	DATA	ETX	Bcc
-----	------	--------	-----	-------	------	-----	-----

☞ Command Data Structure

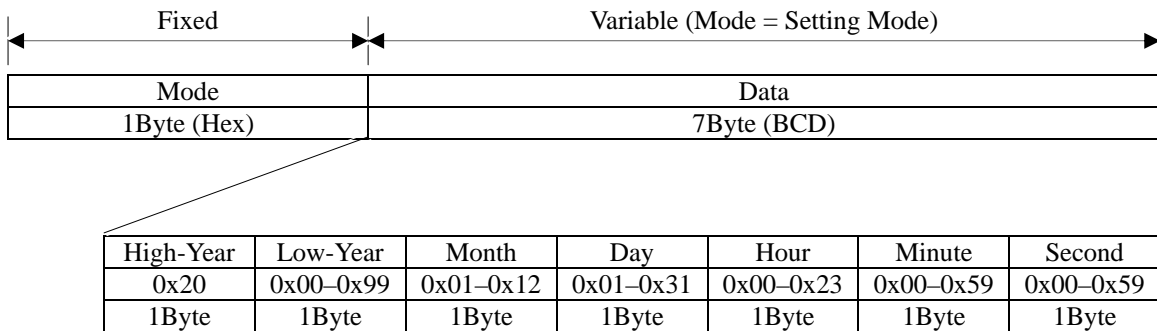

☞ Positive Response Format

SOH	Null	Length	STX	“C21”	GOOD	0x01	DATA	ETX	Bcc
-----	------	--------	-----	-------	------	------	------	-----	-----

☞ Negative Response Format

SOH	Null	Length	STX	“C21”	E-Code	0x00	ETX	Bcc
-----	------	--------	-----	-------	--------	------	-----	-----

☞ Response Data Structure

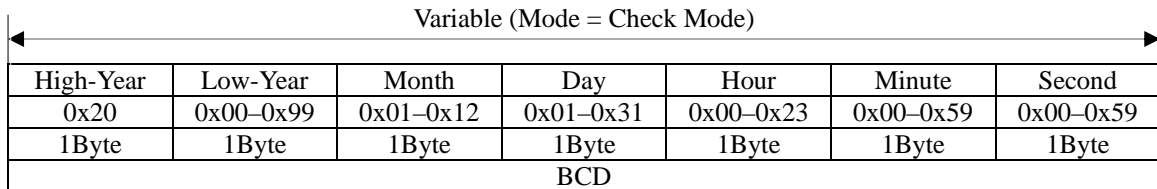

☞ Data Variable

<Mode>

Code	Mode	Detail
0x01	‘Setting Mode’	Set ‘RTC IC’
0x02	‘Check Mode’	Check ‘RTC IC’

☞ Note

‘Day’ is changeable due to the value of ‘Month’.

Doc No	CIP-8XXX SERIES SPECIFICATION	REV	PAGE	DATE
		A	28/71	2009. 04. 02.

2.2 “C24” : It is to set or to check ‘Retry Count’.

☞ Command Format

SOH	Null	Length	STX	“C24”	DATA	ETX	Bcc
-----	------	--------	-----	-------	------	-----	-----

☞ Command Data Structure

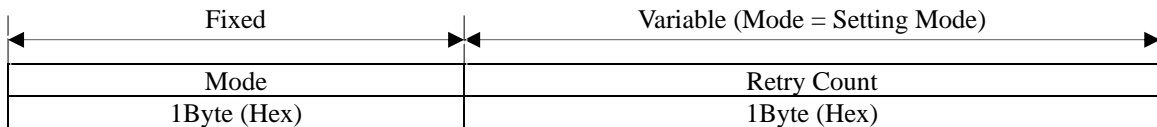

☞ Positive Response Format

SOH	Null	Length	STX	“C24”	GOOD	0x01	DATA	ETX	Bcc
-----	------	--------	-----	-------	------	------	------	-----	-----

☞ Negative Response Format

SOH	Null	Length	STX	“C24”	E-Code	0x00	ETX	Bcc
-----	------	--------	-----	-------	--------	------	-----	-----

☞ Response Data Structure

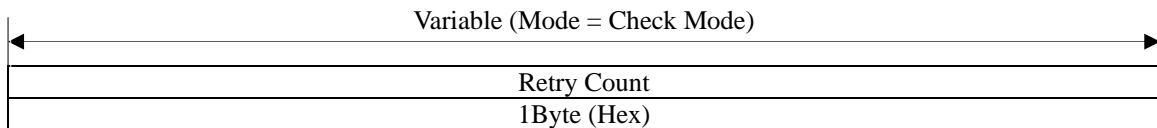

☞ Data Variable

<Mode>

Code	Mode	Detail
0x01	‘Setting Mode’	Set ‘Retry Count’
0x02	‘Check Mode’	Check ‘Retry Count’

<Retry Count>

Code	Setting	Detail	Note
0x00	NON	Do not retry	
0x01	Once	Execute the instruction again.	
0x02	Twice	Retry it twice	
0x03	Three times	Retry it three times	Default

Doc No	CIP-8XXX SERIES SPECIFICATION	REV	PAGE	DATE
		A	29/71	2009. 04. 02.

2.3 “C25” : It is to set or to check ‘Buzz Control’.

☞ Command Format

SOH	Null	Length	STX	“C25”	DATA	ETX	Bcc
-----	------	--------	-----	-------	------	-----	-----

☞ Command Data Structure

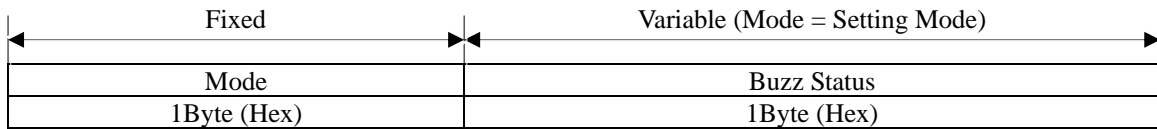

☞ Positive Response Format

SOH	Null	Length	STX	“C25”	GOOD	0x01	DATA	ETX	Bcc
-----	------	--------	-----	-------	------	------	------	-----	-----

☞ Negative Response Format

SOH	Null	Length	STX	“C25”	E-Code	0x00	ETX	Bcc
-----	------	--------	-----	-------	--------	------	-----	-----

☞ Response Data Structure

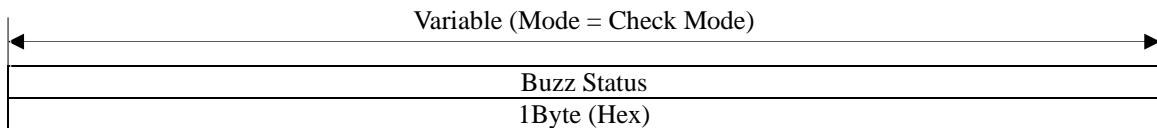

☞ Data Variable

<Mode>

Code	Mode	Detail
0x01	‘Setting Mode’	Set ‘Buzz Control’
0x02	‘Check Mode’	Check ‘Buzz Control’

<Buzz Status>

Code	Setting	Detail	Note
0x01	Buzz Off	Buzz Off	
0x02	Buzz On	Buzz On	Default

Doc No	CIP-8XXX SERIES SPECIFICATION	REV	PAGE	DATE
		A	30/71	2009. 04. 02.

2.4 “C26” : It is to change ‘Baud Rate’.

☞ Command Format

SOH	Null	Length	STX	“C26”	DATA	ETX	Bcc
-----	------	--------	-----	-------	------	-----	-----

☞ Command Data Structure

Baud Rate
1Byte (Hex)

☞ Positive Response Format.

SOH	Null	Length	STX	“C26”	GOOD	0x01	ETX	Bcc
-----	------	--------	-----	-------	------	------	-----	-----

☞ Negative Response Format

SOH	Null	Length	STX	“C26”	E-Code	0x00	ETX	Bcc
-----	------	--------	-----	-------	--------	------	-----	-----

☞ Data Variable

<Baud Rate>

Code	Setting	Detail	Note
0x01	9600Bps	Set Baud Rate to be 9600Bps	
0x02	19200Bps	Set Baud Rate to be 19200Bps	
0x03	RFU		
0x04	38400Bps	Set Baud Rate to be 38400Bps	Default
0x05	57600Bps	Set Baud Rate to be 57600Bps	

2.5 “C42” : Software RESET for Main Board.

☞ Command Format.

SOH	Null	Length	STX	“C42”	ETX	Bcc
-----	------	--------	-----	-------	-----	-----

☞ Positive Response Format.

SOH	Null	Length	STX	“C42”	GOOD	0x01	ETX	Bcc
-----	------	--------	-----	-------	------	------	-----	-----

☞ Negative Response Format.

SOH	Null	Length	STX	“C42”	E-Code	0x00	ETX	Bcc
-----	------	--------	-----	-------	--------	------	-----	-----

☞ Note

This “C42” Software RESET command is effective for CIP8XXX MAIN BOARD only.

Card Dispenser and Card Reader is not RESETed.

With this software RESET, all the data setted at CIP8XXX return to DEFAULT value.

After “RESET”, minimum 3 seconds is required before running to get secure operation.

Doc No	CIP-8XXX SERIES SPECIFICATION	REV	PAGE	DATE
		A	31/71	2009. 04. 02.

2.6 “C40” : The BUZZ is operate by internal terminal.

☞ Command Format

SOH	Null	Length	STX	“C40”	DATA	ETX	Bcc
-----	------	--------	-----	-------	------	-----	-----

☞ Command Data Structure

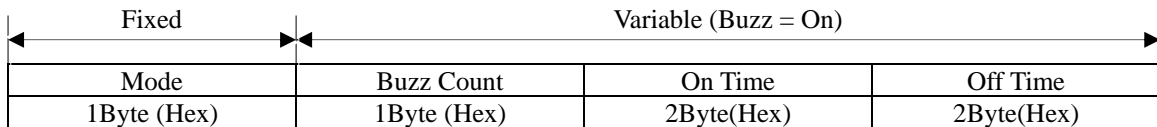

☞ Positive Response Format

SOH	Null	Length	STX	“C40”	GOOD	0x01	ETX	Bcc
-----	------	--------	-----	-------	------	------	-----	-----

☞ Negative Response Format

SOH	Null	Length	STX	“C40”	E-Code	0x00	ETX	Bcc
-----	------	--------	-----	-------	--------	------	-----	-----

☞ Data Variable

<Mode>

Code	Buzz	Detail
0x01	On	Set Buzz ON
0x02	Off	Set Buzz OFF

<Buzz Count>

Code	Buzz Count	Detail	Note
0x00	Continuous	Buzz continuous occur.	Default
0x01	1	Buzz one time occur.	Note
0x02	2	Buzz two times occur.	Note
---	---	---	---
0x64	100	Buzz hundred times occur.	Note

<On Time/Off Time>

Code	Range	Detail	Note
On Time	100 – 10000	Buzz sound active time	mSec
Off Time	100 – 10000	Buzz sound nonactive time.	mSec

<On Time>, <Off Time>

High Byte	Low Byte
-----------	----------

☞ Note

If set ‘Buzz one time occur’, after the terminal is Buzz one time occur, return to ‘Buzz Off’ state.

Doc No	CIP-8XXX SERIES SPECIFICATION	REV	PAGE	DATE
		A	32/71	2009. 04. 02.

3 MOVE.

3.1 “C31” : It is to take a card from Cartridge and to move it to Card Reader / Writer Module.

☞ Command Format

SOH	Null	Length	STX	“C31”	DATA	ETX	Bcc
-----	------	--------	-----	-------	------	-----	-----

☞ Command Data Structure

Cartridge	Module
1Byte (Hex : 0x00)	1Byte (Hex)

☞ Positive Response Format

SOH	Null	Length	STX	“C31”	GOOD	0x01	ETX	Bcc
-----	------	--------	-----	-------	------	------	-----	-----

☞ Negative Response Format

SOH	Null	Length	STX	“C31”	E-Code	0x00	ETX	Bcc
-----	------	--------	-----	-------	--------	------	-----	-----

☞ Data Variable

<Module>

Code	Setting	Detail
0x01	MSRW	Card transport to MSRW Module
0x02	IC	Card transport to IC Module
0x03	RF	Card transport to RF Module

3.2 “C32” : It is take card to Card Reader / Writer Module.

☞ Command Format

SOH	Null	Length	STX	“C32”	DATA	ETX	Bcc
-----	------	--------	-----	-------	------	-----	-----

☞ Command Data Structure

Module
1Byte (Hex)

☞ Positive Response Format

SOH	Null	Length	STX	“C32”	GOOD	0x01	ETX	Bcc
-----	------	--------	-----	-------	------	------	-----	-----

☞ Negative Response Format

SOH	Null	Length	STX	“C32”	E-Code	0x00	ETX	Bcc
-----	------	--------	-----	-------	--------	------	-----	-----

☞ Data Variable

<Module>

Code	Setting	Detail
0x01	MSRW	Card transport to MSRW Module
0x02	IC	Card transport to IC Module
0x03	RF	Card transport to RF Module

Doc No	CIP-8XXX SERIES SPECIFICATION	REV	PAGE	DATE
		A	33/71	2009. 04. 02.

3.3 “C34” : It takes card to Bin Box (Capture).

☞ Command Format.

SOH	Null	Length	STX	“C34”	ETX	Bcc
-----	------	--------	-----	-------	-----	-----

☞ Positive Response Format.

SOH	Null	Length	STX	“C34”	GOOD	0x01	ETX	Bcc
-----	------	--------	-----	-------	------	------	-----	-----

☞ Negative Response Format.

SOH	Null	Length	STX	“C34”	E-Code	0x00	ETX	Bcc
-----	------	--------	-----	-------	--------	------	-----	-----

3.4 “C36” : Dispense the card to front and Drop it out of the unit.

☞ Command Format

SOH	Null	Length	STX	“C36”	ETX	Bcc
-----	------	--------	-----	-------	-----	-----

☞ Positive Response Format

SOH	Null	Length	STX	“C36”	GOOD	0x01	ETX	Bcc
-----	------	--------	-----	-------	------	------	-----	-----

☞ Negative Response Format

SOH	Null	Length	STX	“C36”	E-Code	0x00	ETX	Bcc
-----	------	--------	-----	-------	--------	------	-----	-----

☞ Note

The CIP-8xxx model with bezel or shutter can not use “C36” command.

3.5 “C37” : Dispense the card to front and hold it at the exit roller of the unit.

☞ Command Format

SOH	Null	Length	STX	“C37”	ETX	Bcc
-----	------	--------	-----	-------	-----	-----

☞ Positive Response Format

SOH	Null	Length	STX	“C37”	GOOD	0x01	ETX	Bcc
-----	------	--------	-----	-------	------	------	-----	-----

☞ Negative Response Format

SOH	Null	Length	STX	“C37”	E-Code	0x00	ETX	Bcc
-----	------	--------	-----	-------	--------	------	-----	-----

3.6 “C38” : Raise the Lift.

☞ Command Format

SOH	Null	Length	STX	“C38”	ETX	Bcc
-----	------	--------	-----	-------	-----	-----

☞ Positive Response Format

SOH	Null	Length	STX	“C38”	GOOD	0x01	ETX	Bcc
-----	------	--------	-----	-------	------	------	-----	-----

☞ Negative Response Format

SOH	Null	Length	STX	“C38”	E-Code	0x00	ETX	Bcc
-----	------	--------	-----	-------	--------	------	-----	-----

Doc No	CIP-8XXX SERIES SPECIFICATION	REV	PAGE	DATE
		A	34/71	2009. 04. 02.

3.7 “C39” : Move the card to cartridge.

☞ Command Format

SOH	Null	Length	STX	“C39”	ETX	Bcc
-----	------	--------	-----	-------	-----	-----

☞ Positive Response Format

SOH	Null	Length	STX	“C39”	GOOD	0x01	ETX	Bcc
-----	------	--------	-----	-------	------	------	-----	-----

☞ Negative Response Format

SOH	Null	Length	STX	“C39”	E-Code	0x00	ETX	Bcc
-----	------	--------	-----	-------	--------	------	-----	-----

3.8 “C44” : Lower the Lift for collecting.

☞ Command Format

SOH	Null	Length	STX	“C44”	ETX	Bcc
-----	------	--------	-----	-------	-----	-----

☞ Positive Response Format

SOH	Null	Length	STX	“C44”	GOOD	0x01	ETX	Bcc
-----	------	--------	-----	-------	------	------	-----	-----

☞ Negative Response Format

SOH	Null	Length	STX	“C44”	E-Code	0x00	ETX	Bcc
-----	------	--------	-----	-------	--------	------	-----	-----

3.9 “C45” : Lower the Lift.

☞ Command Format

SOH	Null	Length	STX	“C45”	ETX	Bcc
-----	------	--------	-----	-------	-----	-----

☞ Positive Response Format

SOH	Null	Length	STX	“C45”	GOOD	0x01	ETX	Bcc
-----	------	--------	-----	-------	------	------	-----	-----

☞ Negative Response Format

SOH	Null	Length	STX	“C45”	E-Code	0x00	ETX	Bcc
-----	------	--------	-----	-------	--------	------	-----	-----

Doc No	CIP-8XXX SERIES SPECIFICATION	REV	PAGE	DATE
		A	35/71	2009. 04. 02.

◆ *MAGNETIC CARD.*

This section describes the commands that can use at the magnetic card.

The data to be written in every track should be conform to the ISO7816-2 standard, the available character is as follows. For more information about Magnetic card, refer to the ISO7816-2 standard.

Track	Available Character Set	Maximum characters	REMARKS
Track #1	Character, Numbers	76	Except for the special character
Track #2	Numbers	37	
Track #3	Number	104	

The CIP-8XXXX Series provides two features for speedy processing. The first is to provide the command combined with 'From Cartridge' and 'Magnetic Write' command. This feature enables to write on card in the dispenser cartridge at a command.

The second is to lessen the processing time for the 'magnetic read' command repeated after latching the data read from card. To latch data occurs at a point of time when verify in the magnetic write command and execute the magnetic read command. However, the latched data is erased when the card is off from the terminal.

The applicable models of the CIP-8XXXX series are the CIP81XXX(D), CIP82XXX(D), CIP83XXX(D), CIP84XXX(D), the available commands set is as follows.

Item	Cm0	Cm1	Cm2	Detail	Note
MAGNETIC READ/WRITE	'M'	'3'	'1'	Magnetic card one track read	
	'M'	'3'	'3'	Magnetic card one track write	Verify
	'M'	'3'	'4'	Magnetic card write from Cartridge	Verify
	'M'	'3'	'5'	Magnetic card all track read	
	'M'	'3'	'A'	Magnetic Card Read for binary format	
	'M'	'3'	'B'	Magnetic Card Write for binary format	
CLEANING	'M'	'3'	'C'	Magnetic Card Write from Cartridge for binary format	
	'M'	'5'	'1'	MSRW Header Cleaning	

Doc No	CIP-8XXX SERIES SPECIFICATION	REV	PAGE	DATE
		A	36/71	2009. 04. 02.

Basic Magnetic Card Operations:

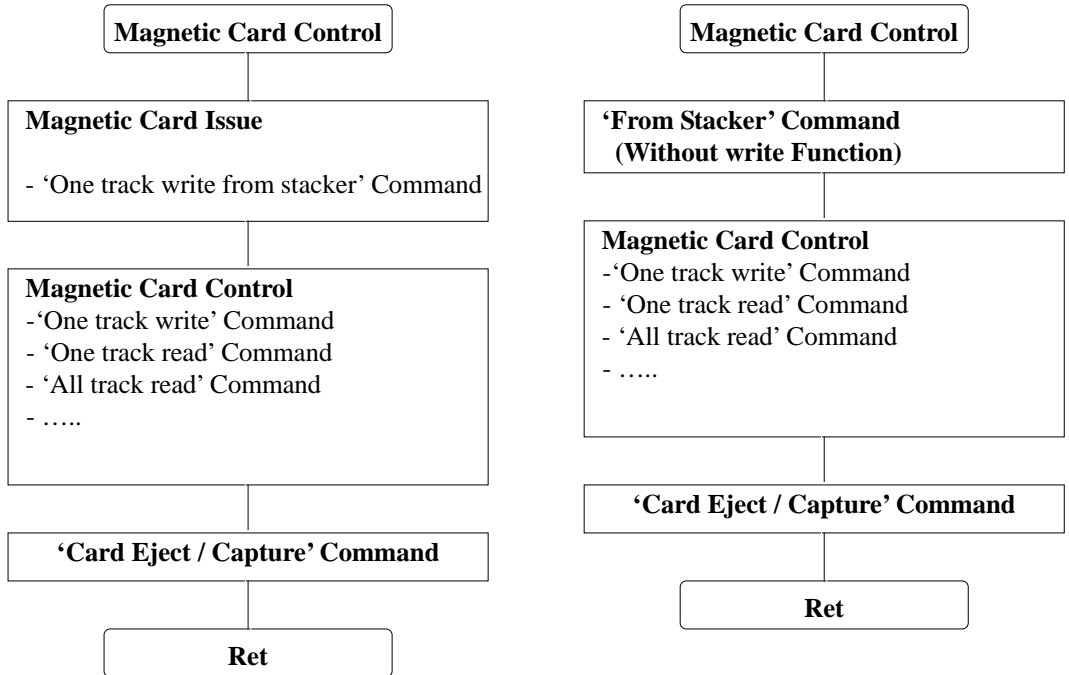

Magnetic Card Operations in the stacker

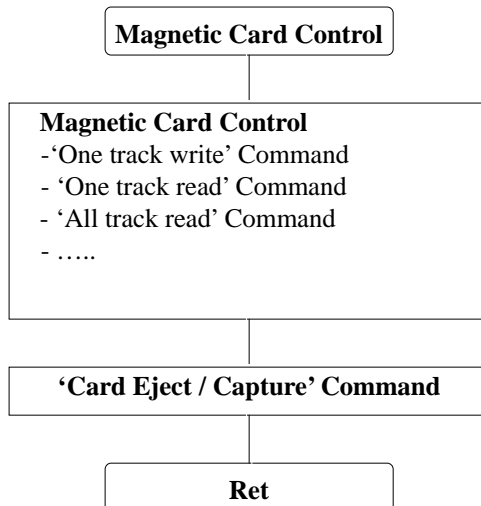

Magnetic Card Operations in the terminal

Doc No	CIP-8XXX SERIES SPECIFICATION	REV	PAGE	DATE
		A	37/71	2009. 04. 02.

1 MAGNETIC READ / WRITE.

1.1 “M31” : It is to read data on track chosen.

Command Format

SOH	Null	Length	STX	“M31”	DATA	ETX	Bcc
-----	------	--------	-----	-------	------	-----	-----

Command Data Structure

Track (1Byte)

Positive Response Format

SOH	Null	Length	STX	“M31”	GOOD	0x01	DATA	ETX	Bcc
-----	------	--------	-----	-------	------	------	------	-----	-----

Negative Response Format

SOH	Null	Length	STX	“M31”	E-Code	0x00	ETX	Bcc
-----	------	--------	-----	-------	--------	------	-----	-----

Response Data Structure

Read Data (ASCII Code)

Data Variable

<Track>

Code	Setting	Detail
0x01	Track 1	Read data on Track 1
0x02	Track 2	Read data on Track 2
0x03	Track 3	Read data on Track 3

Note

If the ‘Magnetic Read’ command is executed normally, the read data is latched.

1.2 “M33” : It is to write data on track chosen.

Command Format

SOH	Null	Length	STX	“M33”	DATA	ETX	Bcc
-----	------	--------	-----	-------	------	-----	-----

Command Data Structure

Track 1Byte (Hex)	Write Data (ASCII Code)
----------------------	----------------------------

Positive Response Format

SOH	Null	Length	STX	“M33”	GOOD	0x01	ETX	Bcc
-----	------	--------	-----	-------	------	------	-----	-----

Negative Response Format

SOH	Null	Length	STX	“M33”	E-Code	0x00	ETX	Bcc
-----	------	--------	-----	-------	--------	------	-----	-----

Data Variable

<Track>

Code	Setting	Detail
0x01	Track 1	Write data to Track 1
0x02	Track 2	Write data to Track 2
0x03	Track 3	Write data to Track 3

Note

If the ‘Magnetic Write’ command is executed normally, the written data is latched. This command has the ‘Verify’ feature.

Doc No	CIP-8XXX SERIES SPECIFICATION	REV	PAGE	DATE
		A	38/71	2009. 04. 02.

1.3 “M34” : It is to take a card from Cartridge and to write data to a selected track.

☞ Command Format

SOH	Null	Length	STX	“M34”	DATA	ETX	Bcc
-----	------	--------	-----	-------	------	-----	-----

☞ Command Data Structure

Cartridge	Track	Write Data
1Byte (Hex : 0x00)	1Byte (Hex)	(ASCII Code)

☞ Positive Response Format

SOH	Null	Length	STX	“M34”	GOOD	0x01	ETX	Bcc
-----	------	--------	-----	-------	------	------	-----	-----

☞ Negative Response Format

SOH	Null	Length	STX	“M34”	E-Code	0x00	ETX	Bcc
-----	------	--------	-----	-------	--------	------	-----	-----

☞ Data Variable

<Track>

Code	Setting	Detail
0x01	Track 1	Write data to Track 1
0x02	Track 2	Write data to Track 2
0x03	Track 3	Write data to Track 3

☞ Note

This command has the Data ‘Latch ‘and ‘Verify’ features.

1.4 “M35” : It is to read data from all three tracks.

☞ Command Format

SOH	Null	Length	STX	“M35”	ETX	Bcc
-----	------	--------	-----	-------	-----	-----

☞ Positive Response Format

SOH	Null	Length	STX	“M35”	GOOD	0x01	DATA	ETX	Bcc
-----	------	--------	-----	-------	------	------	------	-----	-----

☞ Negative Response Format

SOH	Null	Length	STX	“M35”	E-Code	0x00	ETX	Bcc
-----	------	--------	-----	-------	--------	------	-----	-----

☞ Response Data Structure

0x01 or 0xFF	Track1 Data	0x02 or 0xFF	Track2 Data	0x03 or 0xFF	Track3 Data
1Byte (Hex)	(ASCII)	1Byte (Hex)	(ASCII)	1Byte (Hex)	(ASCII)

☞ Note

If the ‘Magnetic Read’ command is executed normally, the read data is latched.

Doc No	CIP-8XXX SERIES SPECIFICATION	REV	PAGE	DATE
		A	39/71	2009. 04. 02.

1.1 “M3A” : It is to read data on track chosen for binary format.

☞ Command Format

SOH	Null	Length	STX	“M3A”	DATA	ETX	Bcc
-----	------	--------	-----	-------	------	-----	-----

☞ Command Data Structure

Track (1Byte)

☞ Positive Response Format

SOH	Null	Length	STX	“M3A”	GOOD	0x01	DATA	ETX	Bcc
-----	------	--------	-----	-------	------	------	------	-----	-----

☞ Negative Response Format

SOH	Null	Length	STX	“M3A”	E-Code	0x00	ETX	Bcc
-----	------	--------	-----	-------	--------	------	-----	-----

☞ Response Data Structure

Read Data (Binary Code)

☞ Data Variable

<Track>

Code	Setting	Detail
0x01	Track 1	Read data on Track 1
0x02	Track 2	Read data on Track 2
0x03	Track 3	Read data on Track 3

☞ Note

If the ‘Magnetic Read’ command is executed normally, the read data is latched.

1.2 “M3B” : It is to write data on track chosen for binary format.

☞ Command Format

SOH	Null	Length	STX	“M3B”	DATA	ETX	Bcc
-----	------	--------	-----	-------	------	-----	-----

☞ Command Data Structure

Track	Write Data
1Byte (Hex)	(Binary Code)

☞ Positive Response Format

SOH	Null	Length	STX	“M3B”	GOOD	0x01	ETX	Bcc
-----	------	--------	-----	-------	------	------	-----	-----

☞ Negative Response Format

SOH	Null	Length	STX	“M3B”	E-Code	0x00	ETX	Bcc
-----	------	--------	-----	-------	--------	------	-----	-----

☞ Data Variable

<Track>

Code	Setting	Detail
0x01	Track 1	Write data to Track 1
0x02	Track 2	Write data to Track 2
0x03	Track 3	Write data to Track 3

☞ Note

If the ‘Magnetic Write’ command is executed normally, the written data is latched. This command has the ‘Verify’ feature.

Doc No	CIP-8XXX SERIES SPECIFICATION	REV	PAGE	DATE
		A	40/71	2009. 04. 02.

1.3 “M3C” : It is to take a card from Cartridge and to write data to a selected track for binary format.

☞ Command Format

SOH	Null	Length	STX	“M3C”	DATA	ETX	Bcc
-----	------	--------	-----	-------	------	-----	-----

☞ Command Data Structure

Cartridge	Track	Write Data
1Byte (Hex : 0x00)	1Byte (Hex)	(Binary Code)

☞ Positive Response Format

SOH	Null	Length	STX	“M3C”	GOOD	0x01	ETX	Bcc
-----	------	--------	-----	-------	------	------	-----	-----

☞ Negative Response Format

SOH	Null	Length	STX	“M3C”	E-Code	0x00	ETX	Bcc
-----	------	--------	-----	-------	--------	------	-----	-----

☞ Data Variable

<Track>

Code	Setting	Detail
0x01	Track 1	Write data to Track 1
0x02	Track 2	Write data to Track 2
0x03	Track 3	Write data to Track 3

☞ Note

This command has the Data ‘Latch ‘and ‘Verify’ features.

2 CLEANING.

2.1 “M51” : It is to clean Magnetic Head mounted inside MSR.W.

☞ Command Format

SOH	Null	Length	STX	“M51”	ETX	Bcc
-----	------	--------	-----	-------	-----	-----

☞ Positive Response Format

SOH	Null	Length	STX	“M51”	GOOD	0x01	ETX	Bcc
-----	------	--------	-----	-------	------	------	-----	-----

☞ Negative Response Format

SOH	Null	Length	STX	“M51”	E-Code	0x00	ETX	Bcc
-----	------	--------	-----	-------	--------	------	-----	-----

Doc No	CIP-8XXX SERIES SPECIFICATION	REV	PAGE	DATE
		A	41/71	2009. 04. 02.

◆ *IC CARD.*

This section describes the commands that can use at the IC card.

The IC card should conform to the ISO7816-4 T=0 and T=1 , these cards is available

The applicable models in the CIP8XXX Series are the CIP82XXX(D), CIP82XXX(D), CIP85XXX(D), CIP87XXX(D), and the available commands are as follows.

Item	Cm0	Cm1	Cm2	Detail	Note
IC CONTROL	'1'	'2'	'1'	IC Card Reset	
	'1'	'2'	'2'	IC Card Direct Control	

Select the card Protocol or Speed & IC module baud rate

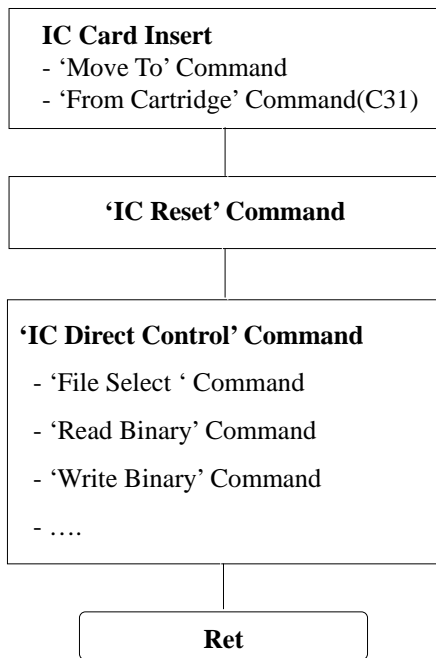

Doc No	CIP-8XXX SERIES SPECIFICATION	REV	PAGE	DATE
		A	42/71	2009. 04. 02.

1. IC CONTROL.

1.1 “I21” : Reset the IC card and receive the ATR from card.

☞ Command Format

SOH	Null	Length	STX	“I21”	ETX	Bcc
-----	------	--------	-----	-------	-----	-----

☞ Positive Response Format

SOH	Null	Length	STX	“I21”	GOOD	0x01	DATA	ETX	Bcc
-----	------	--------	-----	-------	------	------	------	-----	-----

☞ Negative Response Format

SOH	Null	Length	STX	“I21”	E-Code	0x00	ETX	Bcc
-----	------	--------	-----	-------	--------	------	-----	-----

☞ Response Data Structure

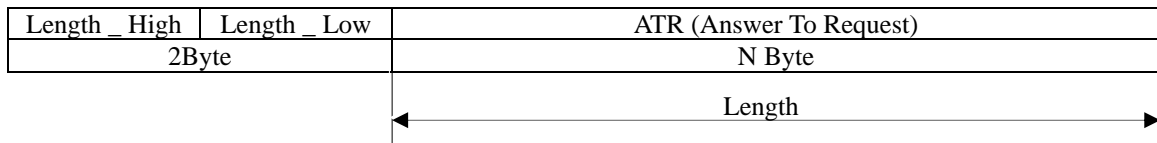

☞ Example

SAMSUNG SCOS ATR

High 8Byte	0x3B	0x6B	0x00	0x00	0x80	0x31	0x80	0x63
Low 7Byte	0x53	0x46	0x01	0x83	0x03	0x90	0x00	

1.2 “I22” : Control the card conforming to the ISO 7816 T = 0 and T =1 , ISO 7816 – 4 standard directly.

☞ Command Format

SOH	Null	Length	STX	“I22”	DATA	ETX	Bcc
-----	------	--------	-----	-------	------	-----	-----

☞ Command Data Structure

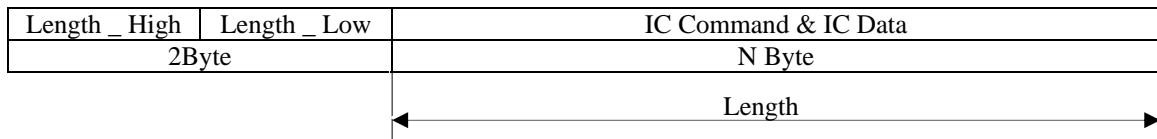

☞ Positive Response Format

SOH	Null	Length	STX	“I22”	GOOD	0x01	DATA	ETX	Bcc
-----	------	--------	-----	-------	------	------	------	-----	-----

☞ Negative Response Format

SOH	Null	Length	STX	“I22”	E-Code	0x00	ETX	Bcc
-----	------	--------	-----	-------	--------	------	-----	-----

☞ Response Data Structure

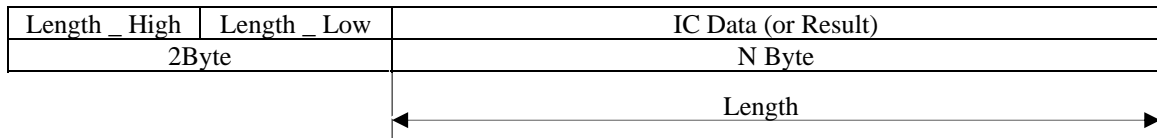

Doc No	CIP-8XXX SERIES SPECIFICATION	REV	PAGE	DATE
		A	43/71	2009. 04. 02.

IC Command & IC Data Structure

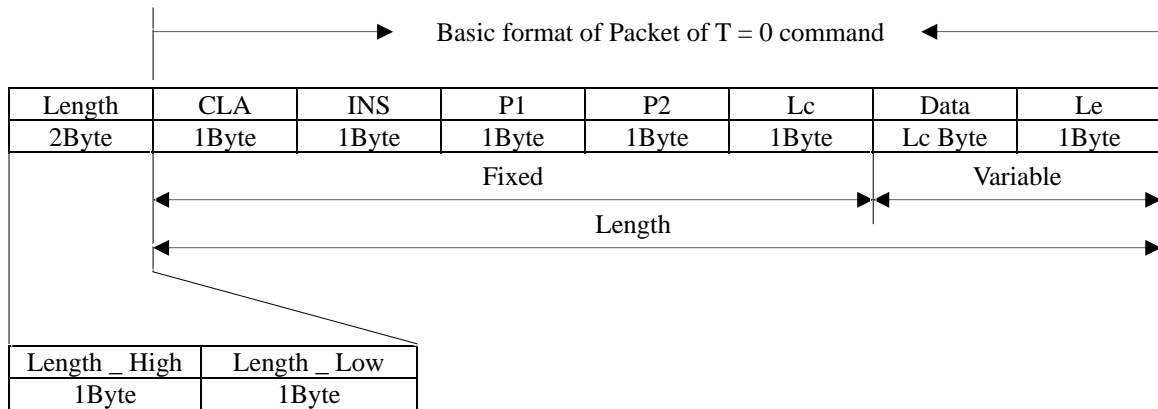

CLA	Class	Note
INS	Instruction	
P1	Offset(High Value)	
P2	Offset(Low Value)	
Lc	A number of data to transfer	Max Value : 255
Data	Data to Transfer	
Le	A number of data to receive	

Format of T = 0 Command

Command	INS Code (Hex Value)
Read Binary Command	B0
Write Binary Command	D0
Update Binary Command	D6
Erase Binary Command	0E
Read Record(s) Command	B2
Write Record Command	D2
Append Record Command	E2
Update Record Command	DC
Get Data Command	CA
Put Data Command	DA
Select File Command	A4
Verify Command	20
Internal Authenticate Command	88
External Authenticate Command	82
Get Challenge Command	84
Manage Channel Command	70

For more information, refer to the ISO 7816 – 4 standard.

Doc No	CIP-8XXX SERIES SPECIFICATION	REV	PAGE	DATE
		A	44/71	2009. 04. 02.

◆ *RF CARD*

This section describes the commands that can use at the 'RF CARD'.

The RF Module of his model supports only the MIFARE card.

The applicable models of the CIP8XXXX Series are the CIP84XXX(D), CIP86XXX(D), CIP87XXX(D), the available commands are as follows.

Item	Cm0	Cm1	Cm2	Detail	Note
RF CARD READ /WRITE	'R'	'3'	'1'	Read RF card data in block range	
	'R'	'3'	'2'	Write RF card in block range	
	'R'	'3'	'6'	Read RF card in sector range	
	'R'	'3'	'7'	Write RF card in sector range	
BALANCE	'R'	'4'	'1'	Increment balance in RF card	
	'R'	'4'	'2'	Decrement balance in RF card	
CHANGE SECRET KEY	'R'	'5'	'1'	Change 'Secret Key' to other key	
	'R'	'5'	'2'	Change 'Secret Key' to all the same Key Value	
	'R'	'5'	'3'	Select 'Secret Key Index'	
	'R'	'5'	'4'	Change RF Card 'Secret Key' to other key	
RF DETECT	'R'	'6'	'1'	Check RF card in antenna area	

To use the RF card, you need to initialize at first.

- Setting and updating of the secret key and secret key index.

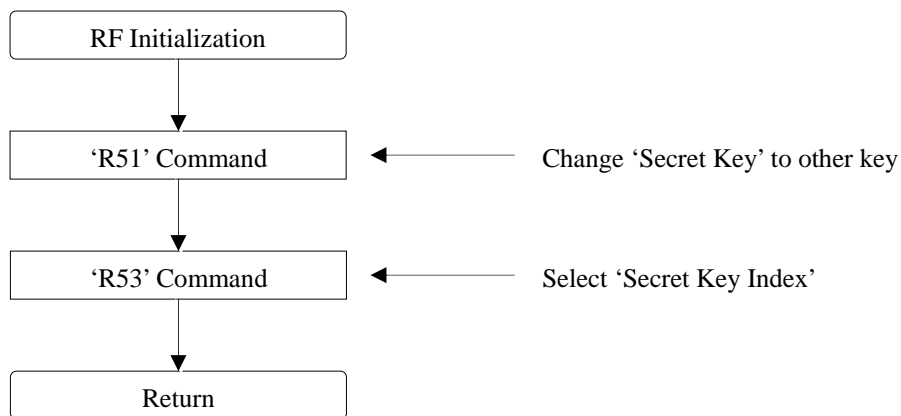

RF Module Initialization

Doc No	CIP-8XXX SERIES SPECIFICATION	REV	PAGE	DATE
		A	45/71	2009. 04. 02.

Basic Operating Procedure of the RF card:

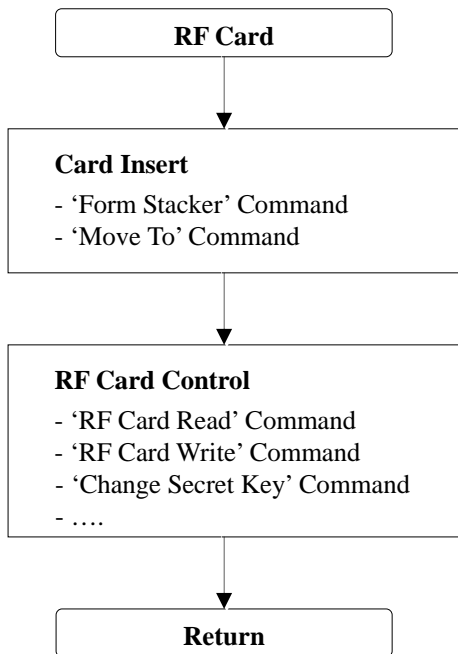

RF Card Basic Operating Procedures

Memory Architecture(map) of the RF card: 8Kbit

Sector	Block	Size	Detail	Note
Sector 0	Block 0	16Byte	RF Card Information	
	Block 1	16Byte		
	Block 2	16Byte		
	Block 3	16Byte	'Sector Key'	Can't use
Sector 1	Block 0	16Byte	User Available Memory	
	Block 1	16Byte		
	Block 2	16Byte		
	Block 3	16Byte	'Sector Key'	Can't use
Sector 2	Block 0	16Byte	User Available Memory	
	Block 1	16Byte		
	Block 2	16Byte		
	Block 3	16Byte	'Sector Key'	Can't use
---	---	---	---	---
Sector 15	Block 0	16Byte	User Available Memory	
	Block 1	16Byte		
	Block 2	16Byte		
	Block 3	16Byte	'Sector Key'	Can't use

Doc No	CIP-8XXX SERIES SPECIFICATION	REV	PAGE	DATE
		A	46/71	2009. 04. 02.

1 RF CARD READ / WRITE

1.1 "R31" : Read RF card data & Secret Key in block range

☞ Command Format

SOH	Null	Length	STX	"R31"	DATA	ETX	Bcc
-----	------	--------	-----	-------	------	-----	-----

☞ Command Data Structure

Sector	Block
0x00 – 0x0f	0x00 – 0x03
1Byte (Hex)	1Byte (Hex)

☞ Positive Response Format

SOH	Null	Length	STX	"R31"	GOOD	0x01	DATA	ETX	Bcc
-----	------	--------	-----	-------	------	------	------	-----	-----

☞ Negative Response Format

SOH	Null	Length	STX	"R31"	E-Code	0x00	ETX	Bcc
-----	------	--------	-----	-------	--------	------	-----	-----

☞ Response Data Structure

Sector	Block	Read Data
1Byte (Hex)	1Byte (Hex)	16 Byte (Hex)

D0	D1	D2	---	D14	D15
1Byte	1Byte	1Byte	---	1Byte	1Byte

1.2 "R32" : Write RF card data in block range

☞ Command Format

SOH	Null	Length	STX	"R32"	DATA	ETX	Bcc
-----	------	--------	-----	-------	------	-----	-----

☞ Command Data Structure

Sector	Block	Write Data
0x00 – 0x0f	0x00 – 0x02	0x00 – 0xff
1Byte (Hex)	1Byte (Hex)	16Byte (Hex)

D0	D1	D2	---	D14	D15
1Byte	1Byte	1Byte	---	1Byte	1Byte

☞ Positive Response Format

SOH	Null	Length	STX	"R32"	GOOD	0x01	ETX	Bcc
-----	------	--------	-----	-------	------	------	-----	-----

☞ Negative Response Format

SOH	Null	Length	STX	"R32"	E-Code	0x00	ETX	Bcc
-----	------	--------	-----	-------	--------	------	-----	-----

Doc No	CIP-8XXX SERIES SPECIFICATION	REV	PAGE	DATE
		A	47/71	2009. 04. 02.

1.3 “R36” : Read RF card data in sector range

☞ Command Format

SOH	Null	Length	STX	“R36”	DATA	ETX	Bcc
-----	------	--------	-----	-------	------	-----	-----

☞ Command Data Structure

Sector
0x00 – 0x0f
1Byte (Hex)

☞ Positive Response Format

SOH	Null	Length	STX	“R36”	GOOD	0x01	DATA	ETX	Bcc
-----	------	--------	-----	-------	------	------	------	-----	-----

☞ Negative Response Format

SOH	Null	Length	STX	“R36”	E-Code	0x00	ETX	Bcc
-----	------	--------	-----	-------	--------	------	-----	-----

☞ Response Data Structure

Sector	0x00	Read Data (0)	0x01	Read Data (1)	0x02	Read Data (2)
1Byte (Hex)	1Byte (Hex)	16Byte (Hex)	1Byte (Hex)	16Byte (Hex)	1Byte (Hex)	16Byte (Hex)

D0	D1	D2	---	D14	D15
1Byte	1Byte	1Byte	---	1Byte	1Byte

1.4 “R37” : Write RF card data in sector range (except Sector 0)

☞ Command Format

SOH	Null	Length	STX	“R37”	DATA	ETX	Bcc
-----	------	--------	-----	-------	------	-----	-----

☞ Command Data Structure

Sector	Write Data
0x01 – 0x0f	0x00 – 0xff
1Byte (Hex)	51Byte (Hex)

0x00	Read Data (0)	0x01	Read Data (1)	0x02	Read Data (2)
1Byte (Hex)	16Byte (Hex)	1Byte (Hex)	16Byte (Hex)	1Byte (Hex)	16Byte (Hex)

D0	D1	D2	---	D14	D15
1Byte	1Byte	1Byte	---	1Byte	1Byte

☞ Positive Response Format

SOH	Null	Length	STX	“R37”	GOOD	0x01	ETX	Bcc
-----	------	--------	-----	-------	------	------	-----	-----

☞ Negative Response Format

SOH	Null	Length	STX	“R37”	E-Code	0x00	ETX	Bcc
-----	------	--------	-----	-------	--------	------	-----	-----

Doc No	CIP-8XXX SERIES SPECIFICATION	REV	PAGE	DATE
		A	48/71	2009. 04. 02.

2 BALANCE.

2.1 “R41” : Increment the balance of card to the specified amount.

☞ Command Format

SOH	Null	Length	STX	“R41”	DATA	ETX	Bcc
-----	------	--------	-----	-------	------	-----	-----

☞ Command Data Structure

Sector	Block	Index Value
0x00 – 0x0f	0x00 – 0x02	0x00000000 – 0xffffffff
1Byte (Hex)	1Byte (Hex)	4Byte (Hex)

V0	V1	V2	V3
0x00-0xff	0x00-0xff	0x00-0xff	0x00-0xff
1Byte(Hex, LSB)	1Byte(Hex)	1Byte(Hex)	1Byte(Hex, MSB)

☞ Positive Response Format

SOH	Null	Length	STX	“R41”	GOOD	0x01	ETX	Bcc
-----	------	--------	-----	-------	------	------	-----	-----

☞ Negative Response Format

SOH	Null	Length	STX	“R41”	E-Code	0x00	ETX	Bcc
-----	------	--------	-----	-------	--------	------	-----	-----

☞ Note

The balance should be written in the Electronic Purse format in the card.

2.2 “R42” : Decrement the balance of card to the specified amount..

☞ Command Format

SOH	Null	Length	STX	“R42”	DATA	ETX	Bcc
-----	------	--------	-----	-------	------	-----	-----

☞ Command Data Structure

Sector	Block	Index Value
0x00 – 0x0f	0x00 – 0x02	0x00000000 – 0xffffffff
1Byte (Hex)	1Byte (Hex)	4Byte (Hex)

V0	V1	V2	V3
0x00-0xff	0x00-0xff	0x00-0xff	0x00-0xff
1Byte(Hex, LSB)	1Byte(Hex)	1Byte(Hex)	1Byte(Hex, MSB)

☞ Positive Response Format

SOH	Null	Length	STX	“R42”	GOOD	0x01	ETX	Bcc
-----	------	--------	-----	-------	------	------	-----	-----

☞ Negative Response Format

SOH	Null	Length	STX	“R42”	E-Code	0x00	ETX	Bcc
-----	------	--------	-----	-------	--------	------	-----	-----

☞ Note

The balance should be written in the Electronic Purse format in the card.

Doc No	CIP-8XXX SERIES SPECIFICATION	REV	PAGE	DATE
		A	49/71	2009. 04. 02.

3 SECRET KEY.

3.1 “R51” : Change ‘Secret Key’ to a new key

☞ Command Format

SOH	Null	Length	STX	“R51”	DATA	ETX	Bcc
-----	------	--------	-----	-------	------	-----	-----

☞ Command Data Structure

Sector	KEY A	KEY B
0x00 – 0x0f	0x00 – 0xff	0x00 – 0xff
1Byte (Hex)	6Byte (Hex)	6Byte (Hex)

☞ Positive Response Format

SOH	Null	Length	STX	“R51”	GOOD	0x01	ETX	Bcc
-----	------	--------	-----	-------	------	------	-----	-----

☞ Negative Response Format

SOH	Null	Length	STX	“R51”	E-Code	0x00	ETX	Bcc
-----	------	--------	-----	-------	--------	------	-----	-----

☞ Note

CIP-8XXX Series ‘Secret Key’ Default

KEY A : FFFFFFFFFF

KEY B : FFFFFFFFFF

3.2 “R52” : Change ‘Secret Key’ to all the same key value

☞ Command Format

SOH	Null	Length	STX	“R52”	DATA	ETX	Bcc
-----	------	--------	-----	-------	------	-----	-----

☞ Command Data Structure

KEY A	KEY B
0x00 – 0xff	0x00 – 0xff
6Byte (Hex)	6Byte (Hex)

☞ Positive Response Format

SOH	Null	Length	STX	“R52”	GOOD	0x01	ETX	Bcc
-----	------	--------	-----	-------	------	------	-----	-----

☞ Negative Response Format

SOH	Null	Length	STX	“R52”	E-Code	0x00	ETX	Bcc
-----	------	--------	-----	-------	--------	------	-----	-----

☞ Note

CIP-8XXX Series ‘Secret Key’ Default

KEY A : FFFFFFFFFF

KEY B : FFFFFFFFFF

Doc No	CIP-8XXX SERIES SPECIFICATION	REV	PAGE	DATE
		A	50/71	2009. 04. 02.

3.3 “R53” : Select ‘Secret Key Index’

Command Format

SOH	Null	Length	STX	“R53”	DATA	ETX	Bcc
-----	------	--------	-----	-------	------	-----	-----

Command Data Structure

Index
0x01 – 0x02
1Byte (Hex)

Positive Response Format

SOH	Null	Length	STX	“R53”	GOOD	0x01	ETX	Bcc
-----	------	--------	-----	-------	------	------	-----	-----

Negative Response Format

SOH	Null	Length	STX	“R53”	E-Code	0x00	ETX	Bcc
-----	------	--------	-----	-------	--------	------	-----	-----

Data Variable

<Index>

Code	Setting	Detail
0x01	KEY A	Select ‘Secret Key A’
0x02	KEY B	Select ‘Secret Key B’

Note

CIP-8XXX Series ‘Secret Key Index’ Default

‘Secret Key Index ‘ : KEY A

3.4 “R54” : Change RF card ‘Secret Key’ to other key

Command Format

SOH	Null	Length	STX	“R54”	DATA	ETX	Bcc
-----	------	--------	-----	-------	------	-----	-----

Command Data Structure

- Command data structure without ‘Access Condition’

Sector	KEY A	KEY B
0x00 – 0x0f	0x00 – 0xff	0x00 – 0xff
1Byte (Hex)	6Byte (Hex)	6Byte (Hex)

- Command data structure with ‘Access Condition’

Sector	KEY A	Access	KEY B
0x00 – 0x0f	0x00 – 0xff	0x00 – 0xff	0x00 – 0xff
1Byte (Hex)	6Byte (Hex)	4Byte (Hex)	6Byte (Hex)

Positive Response Format

SOH	Null	Length	STX	“R54”	GOOD	0x01	ETX	Bcc
-----	------	--------	-----	-------	------	------	-----	-----

Negative Response Format

SOH	Null	Length	STX	“R54”	E-Code	0x00	ETX	Bcc
-----	------	--------	-----	-------	--------	------	-----	-----

Warning

If you use this command incorrectly, it couldn’t be authenticated from the card.

Doc No	CIP-8XXX SERIES SPECIFICATION	REV	PAGE	DATE
		A	51/71	2009. 04. 02.

4 RF DETECT.

4.1 "R61" : RF card detect in antenna area

☞ Command Format

SOH	Null	Length	STX	"R61"	ETX	Bcc
-----	------	--------	-----	-------	-----	-----

☞ Positive Response Format

SOH	Null	Length	STX	"R61"	GOOD	DATA	0x01	ETX	Bcc
-----	------	--------	-----	-------	------	------	------	-----	-----

☞ Negative Response Format

SOH	Null	Length	STX	"R61"	E-Code	0x00	ETX	Bcc
-----	------	--------	-----	-------	--------	------	-----	-----

☞ Response Data Structure

Serial Number
Hex Code
4Byte

☞ Note

If the RF card is detected, this command send the serial number to host. But, it doesn't authenticate the Secret Key of the RF card.

Doc No	CIP-8XXX SERIES SPECIFICATION	REV	PAGE	DATE
		A	52/71	2009. 04. 02.

◆ MIFARE ULTRA LIGHT CARD

- Memory Organisation

The 512Bit EEPROM Memory is organized in 16 pages with 4 bytes each.

In the erased state the EEPROM cells are read as a logic “0”, in the written state as a logical “1”

Byte Number	0	1	2	3	Page
Serial Number	SN0	SN1	SN2	BCC0	0
Serial Number	SN3	SN4	SN5	SN6	1
Internal / Lock	BCC1	Internal	Lock0	Lock1	2
OTP	OTP0	OTP1	OTP2	OTP3	3
Data read/write	Data0	Data1	Data2	Data3	4
Data read/write	Data4	Data5	Data6	Data7	5
Data read/write	Data8	Data9	Data10	Data11	6
Data read/write	Data12	Data13	Data14	Data15	7
Data read/write	Data16	Data17	Data18	Data19	8
Data read/write	Data20	Data21	Data22	Data23	9
Data read/write	Data24	Data25	Data26	Data27	10
Data read/write	Data28	Data29	Data30	Data31	11
Data read/write	Data32	Data33	Data34	Data35	12
Data read/write	Data36	Data37	Data38	Data39	13
Data read/write	Data40	Data41	Data42	Data43	14
Data read/write	Data44	Data45	Data46	Data47	15

Note: Bold frame indicates user area

Doc No	CIP-8XXX SERIES SPECIFICATION	REV	PAGE	DATE
		A	53/71	2009. 04. 02.

- UID / SERIAL NUMBER

The unique 7 byte serial number (UID) and its two Check Bytes are programmed into the first 9 bytes of the memory. It therefore covers page 0, page 1 and the first byte of page 2. The second byte of page2 is reserved for internal data. Due to security and system requirements these bytes are write-protected after having been programmed by the IC manufacturer after production

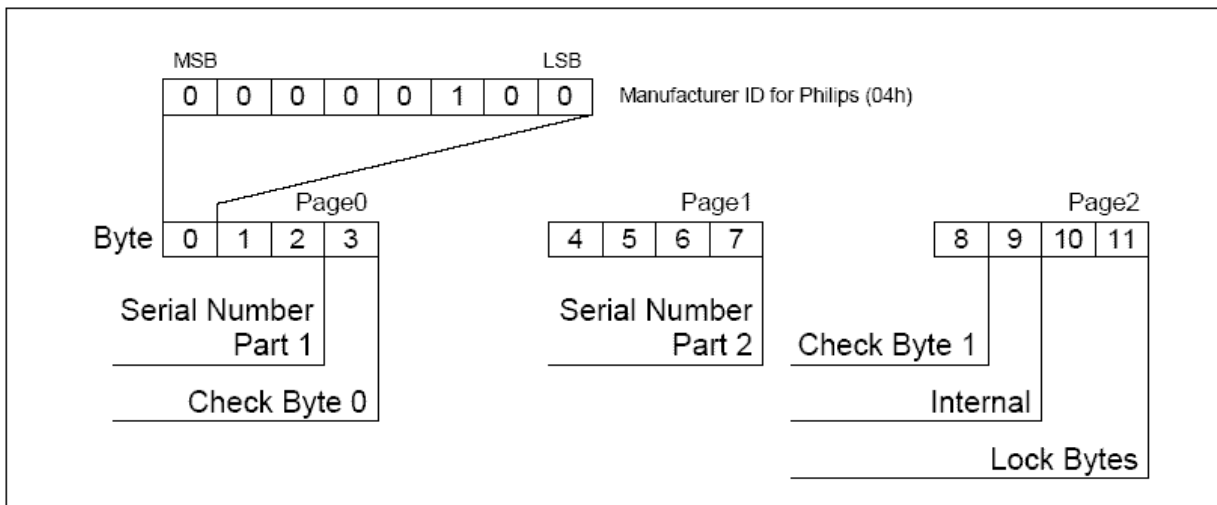

- LOCK BYTES

The bits of Byte 2 and 3 of page 2 represent the field-programmable read-only locking mechanism. Each Page x from 3 (OTP) to 15 may be locked individually to prevent further write access by setting the corresponding locking bit Lx to 1. After locking the page is read-only memory.

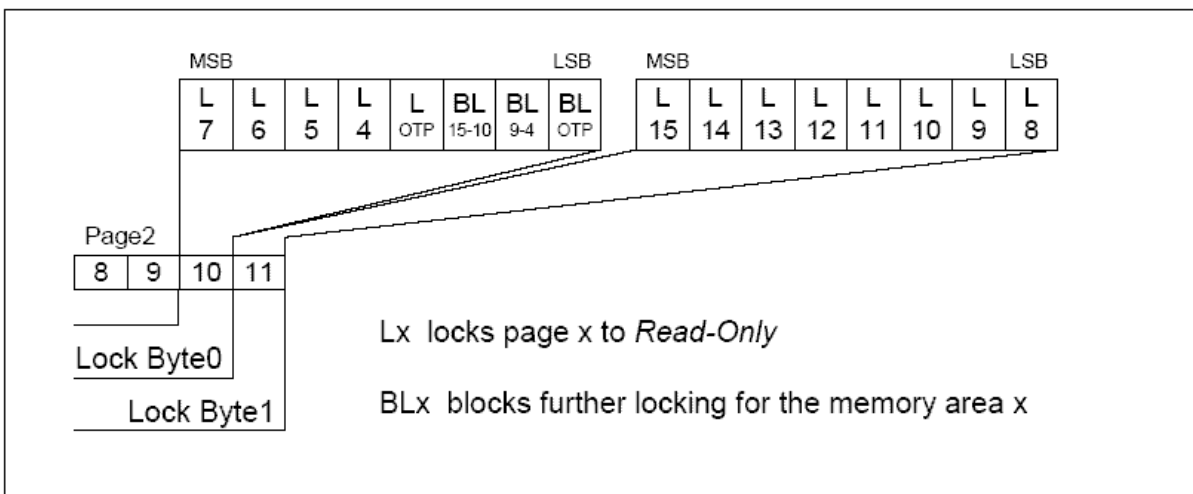

Doc No	CIP-8XXX SERIES SPECIFICATION	REV	PAGE	DATE
		A	54/71	2009. 04. 02.

The 3 least significant bits of lock byte 0 are the block-locking bits. Bit 2 handles pages 15 to 10, bit 1 pages 9 to 4 and bit 0 page 3 (OTP). Once the block-locking bits are set the locking configuration for the corresponding memory area is frozen

- OTP BYTES

Page 3 is the OTP page. It is pre-set to all “0” after production. These bytes may be bit-wise modified by a write command.

Byte	Page 3			
	12	13	14	15
OTP Bytes				

Example			
Default Value		OTP Bytes	
00000000	00000000	00000000	00000000
1st Write Command to page 3			
11111111	11111100	00000101	00000111
Result in page 3			
11111111	11111100	00000101	00000111
2nd Write Command to page 3			
11111111	00000000	00111001	10000000
Result in page 3			
11111111	11111100	00111010	10000111

The bytes of the write command and the current contents of the OTP bytes are bit-wise “or-ed” and the result becomes the new contents of the OTP bytes. This process is irreversible. If a bit is set to “1”, it cannot be changed back to “0” again.

Note : This memory area may be used as a 32 ticks one-time counter.

- DATA PAGES

Pages 4 to 15 constitute the user read/write area. After production the data pages are initialized to all “0”.

Doc No	CIP-8XXX SERIES SPECIFICATION	REV	PAGE	DATE
		A	55/71	2009. 04. 02.

1 MIFARE ULTRA LIGHT CONTROL

1.1 “U31” : It is to read data on Mifare Ultra Light card.

Command Format

SOH	Null	Length	STX	“U31”	DATA	ETX	Bcc
-----	------	--------	-----	-------	------	-----	-----

Command Data Structure

Page (1Byte)

Positive Response Format

SOH	Null	Length	STX	“U31”	GOOD	0x01	DATA	ETX	Bcc
-----	------	--------	-----	-------	------	------	------	-----	-----

Negative Response Format

SOH	Null	Length	STX	“U31”	E-Code	0x00	ETX	Bcc
-----	------	--------	-----	-------	--------	------	-----	-----

Response Data Structure

Page	Read Data
1 Byte (Hex)	16 Bytes (Hex)

1.2 “U32” : It is to write data on Mifare Ultra Light card.

Command Format

SOH	Null	Length	STX	“U32”	DATA	ETX	Bcc
-----	------	--------	-----	-------	------	-----	-----

Command Data Structure

Page	Write Data
1Byte (Hex)	4 Bytes (Hex)

Positive Response Format

SOH	Null	Length	STX	“U32”	GOOD	0x01	ETX	Bcc
-----	------	--------	-----	-------	------	------	-----	-----

Negative Response Format

SOH	Null	Length	STX	“U32”	E-Code	0x00	ETX	Bcc
-----	------	--------	-----	-------	--------	------	-----	-----

1.3 “U41” : It is to read UID (Serial Number) on Mifare Ultra Light card.

Command Format

SOH	Null	Length	STX	“U41”	ETX	Bcc
-----	------	--------	-----	-------	-----	-----

Positive Response Format

SOH	Null	Length	STX	“U41”	GOOD	DATA	0x01	ETX	Bcc
-----	------	--------	-----	-------	------	------	------	-----	-----

Negative Response Format

SOH	Null	Length	STX	“U41”	E-Code	0x00	ETX	Bcc
-----	------	--------	-----	-------	--------	------	-----	-----

Response Data Structure

UID (Serial Number)
7 Bytes (Hex)

Doc No	CIP-8XXX SERIES SPECIFICATION	REV	PAGE	DATE
		A	56/71	2009. 04. 02.

◆ ***PRINT EXAMPLE***

EXAMPLE

Ex1) When the Font Size is 32x32 or 64x32 and Card Space Function Set to OFF

INPUT DATA : A~Z

CARD PRINT:

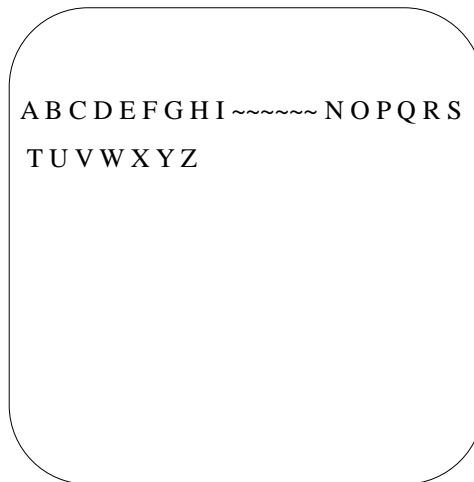

Ex2) When the Font Size is 32x32 or 64x32 and Card Space Function Set to ON

INPUT DATA : A~Z

CARD PRINT:



Doc No	CIP-8XXX SERIES SPECIFICATION	REV	PAGE	DATE
		A	57/71	2009. 04. 02.

Ex3) When the Font Size is 48x24 and Card Space Function Set to OFF

INPUT DATA : A~Z

CARD PRINT:

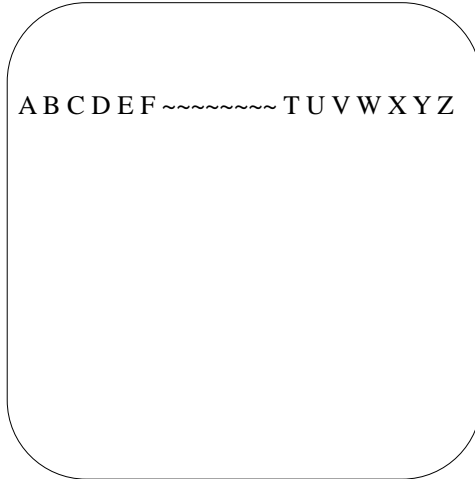

Ex4) When the Font Size is 48x24 and Card Space Function Set to ON

INPUT DATA : A~Z

CARD PRINT:

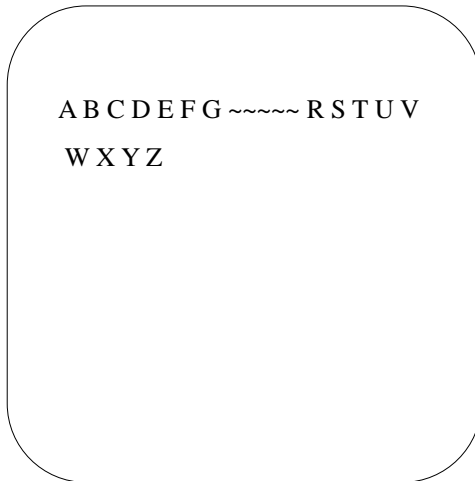

Doc No	CIP-8XXX SERIES SPECIFICATION	REV	PAGE	DATE
		A	58/71	2009. 04. 02.

␣ (ASCII CODE 0x20) : 1character fills blank.

␣ (ASCII CODE 0x0D): Next Line moving.

Ex5)

INPUT DATA: ABCD␣EFGHI

CARD PRINT:

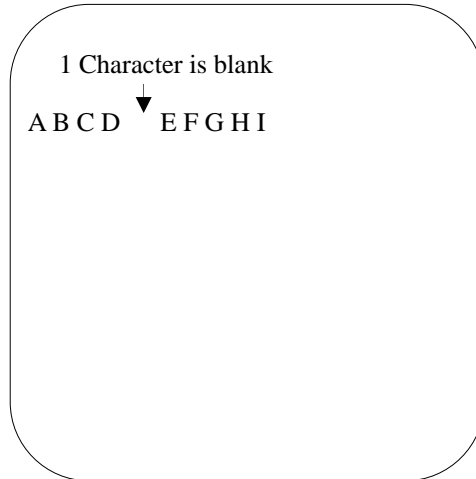

Ex6)

INPUT DATA: ABCD␣EFGHI

CARD PRINT:

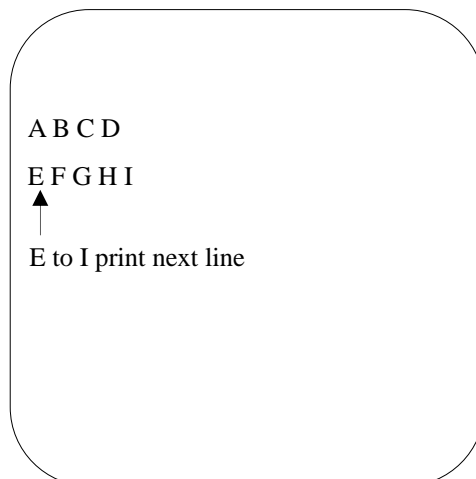

Doc No	CIP-8XXX SERIES SPECIFICATION	REV	PAGE	DATE
		A	59/71	2009. 04. 02.

Basic Thermal Print Operations:

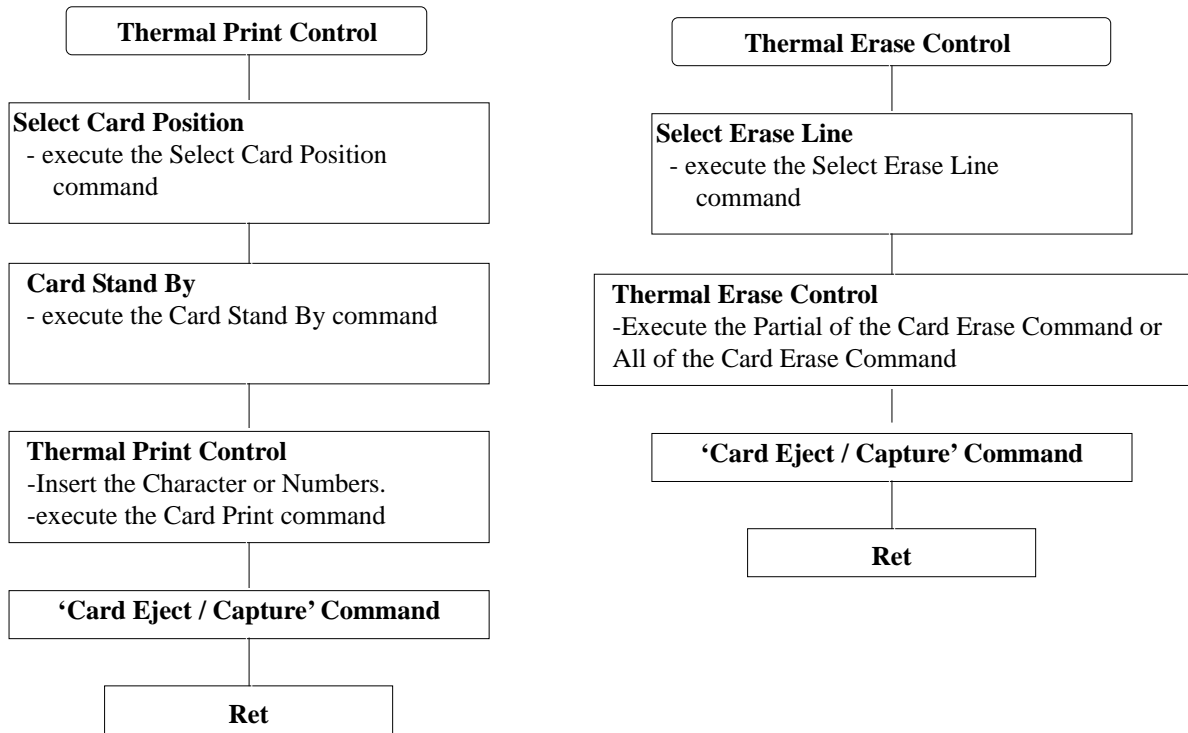

Doc No	CIP-8XXX SERIES SPECIFICATION	REV	PAGE	DATE
		A	60/71	2009. 04. 02.

1. THERMAL PRINTER

1.1 “P31” : It is to select the card position.

Command Format

SOH	Null	Length	STX	“P31”	DATA	ETX	Bcc
-----	------	--------	-----	-------	------	-----	-----

Command Data Structure

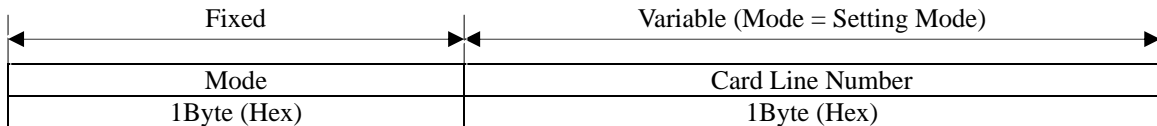

Positive Response Format

SOH	Null	Length	STX	“P31”	GOOD	‘1’	DATA	ETX	Bcc
-----	------	--------	-----	-------	------	-----	------	-----	-----

Negative Response Format

SOH	Null	Length	STX	“P31”	E-Code	‘0’	ETX	Bcc
-----	------	--------	-----	-------	--------	-----	-----	-----

Response Data Structure

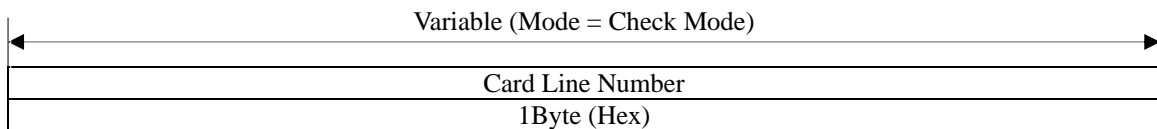

-When the Font Size Set to 32x32.

Number of the Card Line is 1 to 28 LINE (0x00 to 0x1B)

-When the Font Size Set to 48x24.

Number of the Card Line is 1 to 19 LINE (0x00 to 0x12)

-When the Font Size Set to 64x32.

Number of the Card Line is 1 to 14 LINE (0x00 to 0x0D)

Data Variable

<Mode>

Code	Mode	Detail
0x00	‘Check Mode’	Check ‘Card Line Position’
0x01	‘Setting Mode’	Set ‘Card Line Position’

- When the ‘C32’ Command(code:0x05,Setting:Printer) execute after the ‘P31’ command(Select the card position) execute

:Choose the line of the card using the ‘P31’ command(Select the card position) and then The card will move to the chosen position(Printer standby of ‘C32’ Command)

- When the ‘P10’ Command(Printer Standby) execute after the ‘P31’ command(Select the card position) execute

:Choose the line of the card using the ‘P31’ command(Select the card position) and then The card will move to the chosen position and start printing (‘P10’ Command)

Doc No	CIP-8XXX SERIES SPECIFICATION	REV	PAGE	DATE
		A	61/71	2009. 04. 02.

Font: 32x32

48x24

64x32

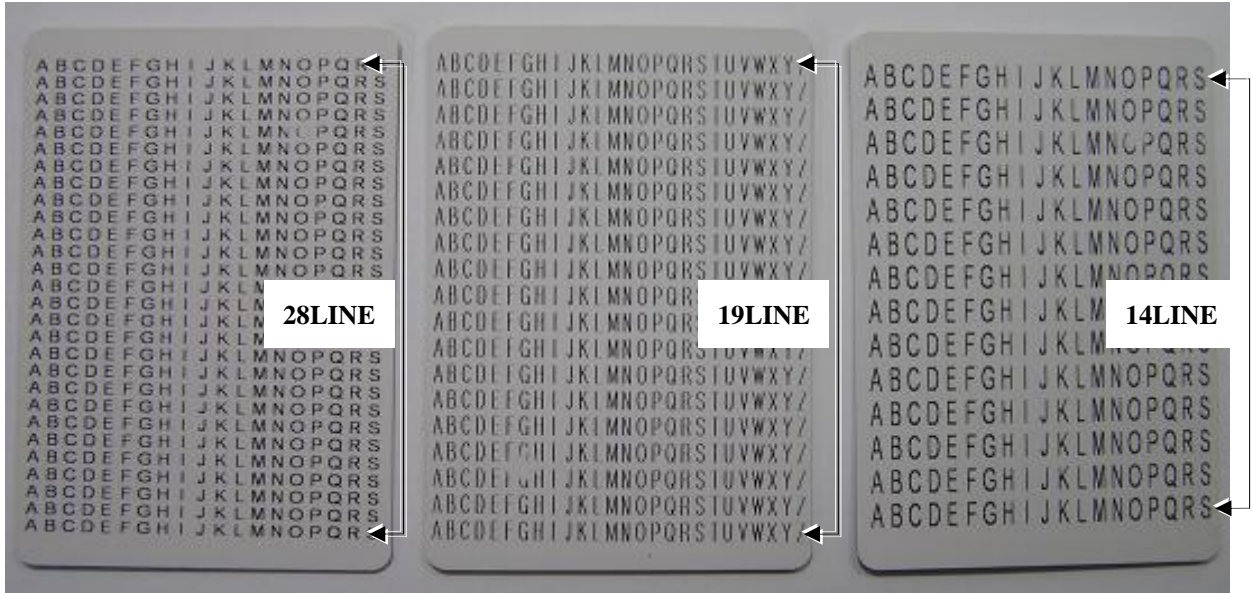

- When the 'P10' Command(Printer Standby) execute after set to Line5(0x04) using the 'P31' command(Select the card position).

Print data: A~Q

Font: 32x32

48x24

64x32



Doc No	CIP-8XXX SERIES SPECIFICATION	REV	PAGE	DATE
		A	62/71	2009. 04. 02.

1.2 “P10” : Move card to Stand-by position, and start printing .

If you ‘C32’(Print Standby)command had already executed, the Card is not moving.

☞ Command Format

SOH	Null	Length	STX	“P10”	DATA	ETX	Bcc
-----	------	--------	-----	-------	------	-----	-----

☞ Command Data Structure

ASCII CODE 0x21(!) to 0x7E(~) (200Byte Max)

☞ Positive Response Format

SOH	Null	Length	STX	“P10”	GOOD	‘1’	ETX	Bcc
-----	------	--------	-----	-------	------	-----	-----	-----

☞ Negative Response Format

SOH	Null	Length	STX	“P10”	E-Code	‘0’	ETX	Bcc
-----	------	--------	-----	-------	--------	-----	-----	-----

☞ Note

⌀ (ASCII CODE 0x20) : 1character fills blank.

␣ (ASCII CODE 0x0D): Next Line moving.

1.3 “P11” : Move card to Stand-by position, and all of a card start printing (test mode).

☞ Command Format

SOH	Null	Length	STX	“P11”	ETX	Bcc
-----	------	--------	-----	-------	-----	-----

☞ Positive Response Format

SOH	Null	Length	STX	“P11”	GOOD	‘1’	ETX	Bcc
-----	------	--------	-----	-------	------	-----	-----	-----

☞ Negative Response Format

SOH	Null	Length	STX	“P11”	E-Code	‘0’	ETX	Bcc
-----	------	--------	-----	-------	--------	-----	-----	-----

Font: 32x32

48x24

64x32



Doc No	CIP-8XXX SERIES SPECIFICATION	REV	PAGE	DATE
		A	63/71	2009. 04. 02.

1.4 “P30”: It is to select the Card Erase Line.

↳ Command Format

SOH	Null	Length	STX	“P30”	DATA	ETX	Bcc
-----	------	--------	-----	-------	------	-----	-----

↳ Command Data Structure

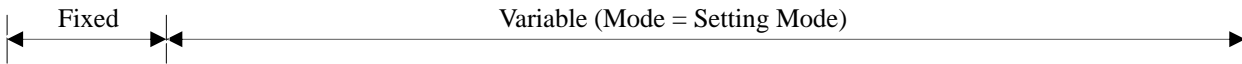

Mode	Card Line Number to erase			
1Byte (Hex)	D0 : 1Byte (Hex)	D1 : 1Byte (Hex)	D2 : 1Byte (Hex)	D3 : 1Byte (Hex)

↳ Positive Response Format

SOH	Null	Length	STX	“P30”	GOOD	‘1’	DATA	ETX	Bcc
-----	------	--------	-----	-------	------	-----	------	-----	-----

↳ Negative Response Format

SOH	Null	Length	STX	“P30”	E-Code	‘0’	ETX	Bcc
-----	------	--------	-----	-------	--------	-----	-----	-----

↳ Response Data Structure

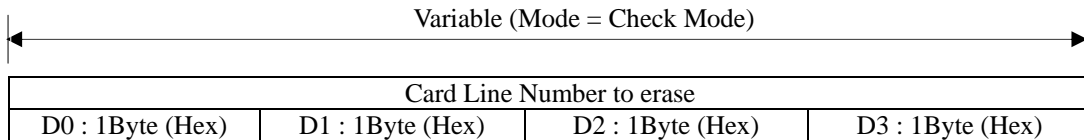

↳ Data Variable

<Mode>

Code	Mode	Detail
0x00	‘Check Mode’	Check ‘Card Line Position’
0x01	‘Setting Mode’	Set ‘Card Line Position’

↳ Card Line Number to erase

D0:

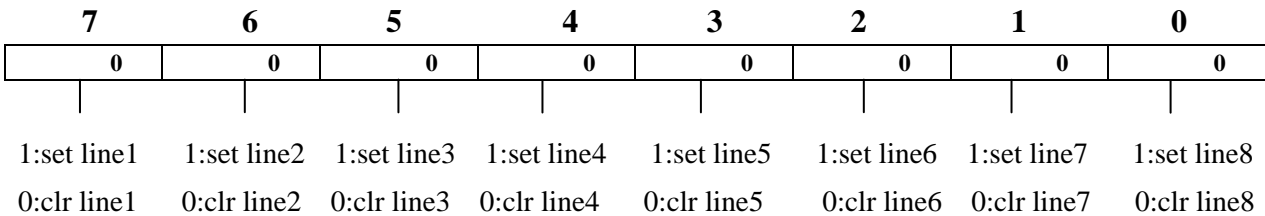

D1:

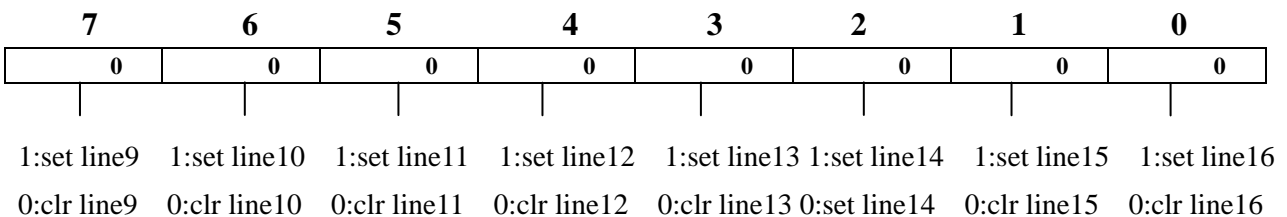

Doc No	CIP-8XXX SERIES SPECIFICATION	REV	PAGE	DATE
		A	64/71	2009. 04. 02.

D2:

7	6	5	4	3	2	1	0
0	0	0	0	0	0	0	0

1:set line17 1:set line18 1:set line19 1:set line20 1:set line21 1:set line22 1:set line23 1:set line24
0:clr line17 0:clr line18 0:clr line19 0:clr line20 0:clr line21 0:clr line22 0:clr line23 0:clr line24

D3:

7	6	5	4	3	2	1	0
0	0	0	0	X	X	X	X

1:set line25 1:set line26 1:set line27 1:set line28 Don't Care
0:clr line25 0:clr line26 0:clr line27 0:clr line28

- When the 'P21'Command(Erase printed card to Partial) execute after the 'P30' command(select the Card Erase Line) execute

:Choose the line of the card using the 'P30' command(Select the card Lines) and then the Printer will erase to the chosen lines ('P21'Command)

***For optimized Erase quality, it is recommended as below.**

1. If you want to erase LINE2, you should select **LINE1**,LINE2 and **LINE3** using the 'P30' command.
2. If you want to erase LINE2 and LINE3, you should select **LINE1**,LINE2 ,LINE3 and **LINE4** using the 'P30' command.

Doc No	CIP-8XXX SERIES SPECIFICATION	REV	PAGE	DATE
		A	65/71	2009. 04. 02.

1.5 “P20” : Erase printed card

☞ Command Format

SOH	Null	Length	STX	“P20”	DATA	ETX	Bcc
-----	------	--------	-----	-------	------	-----	-----

☞ Command Data Structure

0x00(1byte)

☞ Positive Response Format

SOH	Null	Length	STX	“P20”	GOOD	‘1’	ETX	Bcc
-----	------	--------	-----	-------	------	-----	-----	-----

☞ Negative Response Format

SOH	Null	Length	STX	“P20”	E-Code	‘0’	ETX	Bcc
-----	------	--------	-----	-------	--------	-----	-----	-----

1.6 “P21” : Erase printed card to Partial

☞ Command Format

SOH	Null	Length	STX	“P20”	DATA	ETX	Bcc
-----	------	--------	-----	-------	------	-----	-----

☞ Command Data Structure

0x00(1byte)

☞ Positive Response Format

SOH	Null	Length	STX	“P20”	GOOD	‘1’	ETX	Bcc
-----	------	--------	-----	-------	------	-----	-----	-----

☞ Negative Response Format

SOH	Null	Length	STX	“P20”	E-Code	‘0’	ETX	Bcc
-----	------	--------	-----	-------	--------	-----	-----	-----

- When the ‘P21’Command(Erase printed card to Partial) execute after the ‘P30’ command(select the Card Erase Line) execute

:Choose the line of the card using the ‘P30’ command(Select the card Lines) and then the Printer will erase to the chosen lines (‘P21’Command)

***For optimized Erase quality, it is recommended as below.**

1. If you want to erase LINE2, you should select **LINE1**,**LINE2** and **LINE3** using the ‘P30’ command.
2. If you want to erase LINE2 and LINE3, you should select **LINE1**,**LINE2** ,**LINE3** and **LINE4** using the ‘P30’ command.

1.7 “P32” : It is to clean Thermal Printer Head.

☞ Command Format

SOH	Null	Length	STX	“P32”	ETX	Bcc
-----	------	--------	-----	-------	-----	-----

☞ Positive Response Format

SOH	Null	Length	STX	“P32”	GOOD	‘1’	ETX	Bcc
-----	------	--------	-----	-------	------	-----	-----	-----

☞ Negative Response Format

SOH	Null	Length	STX	“P32”	E-Code	‘0’	ETX	Bcc
-----	------	--------	-----	-------	--------	-----	-----	-----

Doc No	CIP-8XXX SERIES SPECIFICATION	REV	PAGE	DATE
		A	66/71	2009. 04. 02.

ERROR DETAIL

<GOOD>

Code : 0x0000
Description: Normal Execution
Procedures: None

<NOT_DEFINE_COMMAND>

Code : 0x2001
Description : Using the command that does not defined in this model.
Action : Use the valid command in this model.

<NOT_USE_COMMAND>

Code : 0x2002
Description : Not available command in this model.
Action : Use the valid command in this model.

<COMM_FRAME_ERROR>

Code : 0x2003
Description : Sending the command that has the invalid communication frame.
Action : Check the data format and the corresponding module specification.

<CARD_JAM>

Code : 0x2004
Description : When the card is jammed.
Action : Remove the jammed card.

<NO_CARD>

Code : 0x2005
Description : No cards.
Action : Insert the card.

Doc No	CIP-8XXX SERIES SPECIFICATION	REV	PAGE	DATE
		A	67/71	2009. 04. 02.

<CARD_PRESENT>

Code : 0x2006

Description : When the card exists already in the terminal.

Action : Eject the card.

<RTC_ERROR>

Code : 0x2008

Description : When the RTC chip is broken.

Action : Replace the board.

<TWO_CARD_ERROR>

Code : 0x2009

Description : When more than one card is presented in the feeder part.

Action : Remove one card.

< CARTRIDGE_JAM _ERROR>

Code : 0x200c

Description : When the cartridge is jammed.

Action : Check if the lift and the motor is normal.

< NO_CARTRIDGE _ERROR>

Code : 0x200d

Description : When the cartridge is not presented.

Action : Equip the cartridge.

< INVALID_POS _ERROR>

Code : 0x200e

Description : When the card is presented in the invalid position for the received command.

Action : Transmit another command.

<DISPENSER_ERROR>

Code : 0x2100

Description : Not Applicable Dispenser.

Action : Reset the terminal and exchange the dispenser..

<DISPENSER_COMM_ERROR>

Doc No	CIP-8XXX SERIES SPECIFICATION	REV	PAGE	DATE
		A	68/71	2009. 04. 02.

Code : 0x2101

Description : Dispenser communication error

Action : Check the communication line and reset the terminal.

<CARTRIDGE_ERROR>

Code : 0x2102

Description : The first CARTRIDGE ERROR

Action : Be sure that the card is loaded at the first cartridge.

<CARTRIDGE_EMPTY>

Code : 0x2105

Description : No card at the first cartridge.

Action : Load the card at the first cartridge.

<CARTRIDGE_FULL>

Code : 0x2111

Description : CARTRIDGE is FULL.

Action : Load the card at the first cartridge.

<CARTRIDGE_WARNING >

Code : 0x2107

Description : There aren't many card left in the cartridge.

Action : Fill the cartridge with cards.

<CHARGING_SENSOR_ERROR>

Code : 0x211a

Description : An error is occurred in one sensor between two charging sensor.

Action : replace the charging sensor.

<DISPENSER_STOP>

Code : 0x211d

Description : Operation has been stopped because of Main Motor Stop Sensor Detection or both of charging sensor error.

Action : Check the lift. Or replace the charging sensor.

<MSRW_ERROR>

Doc No	CIP-8XXX SERIES SPECIFICATION	REV	PAGE	DATE
		A	69/71	2009. 04. 02.

Code : 0x2200

Description : The Card Reader/Writer that cannot use in this model.

Action : Change the Card Reader/Writer.

<MSRW_COMM_ERROR>

Code : 0x2201

Description : The Card Reader/Writer communication error.

Action : Check the communication line and reset the terminal.

<MSRW_WRITE_ERROR>

Code : 0x2202

Description : Error when the MS Reader/Writer is writing on the card.

Action : Clean the header and check the card.

<MSRW_READ_ERROR>

Code : 0x2203

Description : Error when the MS Reader/Writer is reading on the card.

Action : Clean the header and check the card.

<IC_CONTACT_ERROR>

Code : 0x2204

Description : Error while the terminal contacts the IC card.

Action : Be sure that the current card is an IC card.

<IC_CONTROL_ERROR>

Code : 0x2205

Description : Error while the terminal executes the IC card command.

Action : Check if the command is able to use in the contacted card.

<MSRW_BLANK_ERROR >

Code : 0x2209

Description : The respective block of the MS card is blank.

Action : Write the respective black . Or read other written card.

<RF_ERROR>

Code : 0x2300

Description : Unavailable RF module.

Doc No	CIP-8XXX SERIES SPECIFICATION	REV	PAGE	DATE
		A	70/71	2009. 04. 02.

Action : Change the RF MODULE

<RF_COMM_ERROR>

Code : 0x2301

Description : Communication error at the RF Module.

Action : Check the connection socket

<RF_AUTHEN_ERROR>

Code : 0x2302

Description : Authentication Error at the RF Module.

Action : Change the 'SECRET KEY'

<RF_WRITE_ERROR>

Code : 0x2303

Description : Error while the terminal writes at the RF Card.

Action : Be sure that the card exists in the detection range.

<RF_READ_ERROR>

Code : 0x2304

Description : Error while the terminal reads at the RF Card.

Action: Be sure that the card exists in the detection range.

<RF_DETECT_ERROR>

Error Code : 0x2305

Description : No RF Card.

Action : Insert the RF Card into the terminal.

<RF_AMOUNT_ERROR>

Error Code : 0x2306

Description : Error while the terminal increases(or decreases) the balance at the RF card.

Action : Tune the RF module

<CARTRIDGE_FULL>

Code : 0x2505

Description : CARTRIDGE is FULL.

Action : Load the card at the first cartridge.

Doc No	CIP-8XXX SERIES SPECIFICATION	REV	PAGE	DATE
		A	71/71	2009. 04. 02.

Precautions

1. Check if the card exists in cartridge. Otherwise, it may not issue the card.

2. Check the communication line
 - 1) Communication Port, Baud, Parity, and Data Bit, etc.